



COOLMAX SR MAXIMIZER WALL MOUNT

Installation and Operational User Manual



Models

**SRMVW
SRHVW**

TABLE OF CONTENTS

Section Number	Topic	Page Number
1	Product Warranty	4
1.1	Product Specifications	5
2	Product Overview	6
2.1	Why use an MPPT?	6
3	Installation	6
3.1	Mounting	7
4	Wiring	8
5	Circuit Breakers	10
6	Earthing	11
6.1	Connections	11
7	LCD Fault Codes	11
8	Can Communications	12
8.1	CAN Network Topology	12
8.2	CAN Wiring	13
8.3	Shielding	13
8.4	CAN Termination	14
8a	Modbus Communications	14
8a.1	Modbus Network Topology	14
8a.2	Modbus Wiring	15
8a.3	Shielding	16
8a.4	Modbus Termination	16
9	Operating Guidelines	16
9.1	Battery Charging Setup	16
9.2	Temperature Compensation	17
9.3	Relay Alarm / Genset Control	17
9.4	Remote On/OFF Control	18
9.5	Maximizer Startup	18
10	Adjusting The Charge Profile	18
10.1	Real Time	18
10.2	Main Menu	19
10.3	Settings	19
10.4	Set Points	20
10.5	PIN Code	20
10.6	Set Point Edit	21
10.7	Editing OC Voltage Set Point	21

TABLE OF CONTENTS

Section Number	Topic	Page Number
10.8	Editing MP Voltage Set Point	24
10.9	Editing TMP CMP Set Point	27
10.10	Notification Screen.....	30
10.11	Time / Date	31
10.12	Editing the Time	32
10.13	Editing the Date	35
10.14	Comms info.....	37
10.15	Unit Info	38
10.16	Alarms / reset.....	38
11	LCD Power Saving Feature	40
12	Output Charge Power Switch	40
12.1	Battery Charge Power turn On.....	40
12.2	Battery Charge Power Turn Off.....	41
13	PV Array Configuration Notes	41
13.1	Optimal PV Array Configuration	41
13.2	PV Input Blocking Diode	41
13.3	PV Module Power Rating and Mounting Considerations	41
14	Troubleshooting.....	42
14.1	Low Battery Alarm Triggers Often	42
14.2	Battery Bank Using Excessive Water (Electrolyte)	42
15	APPENDIX A – CAN Communications Protocol.....	42
15.1	Overview.....	42
15.2	COOLMAX SR Broadcast Messages.....	43
15.3	COOLMAX SR Command Messages.....	45
16	APPENDIX B – MODBUS Communications Protocol.....	45
16.1	Overview	45
16.2	Modbus Memory Map (Discrete Inputs)	45

Important Safety Information

This User Manual contains important Safety information and Installation instructions for the AERL COOLMAX SR MAXIMIZER Wall Mount MPPT.

The following symbols are used throughout this User Manual to indicate ideal installation methods, potential dangerous conditions and important operational information.



Important

Indicates information that must be followed to ensure proper operation of the COOLMAX SR unit.



Caution

Indicates a critical procedure for the safe Installation of the COOLMAX SR unit. Use extreme caution when performing this task.

PLEASE NOTE:



Caution

- This User Manual provides detailed installation and usage instructions for the COOLMAX SR unit. It is recommended that all of the Instructions and Cautions in this User Manual be read before beginning installation.
- Only qualified electricians and technicians should install the COOLMAX SR System. This manual is intended for all Installation technicians and the system owner.
- Do not disassemble or attempt to repair the COOLMAX SR unit unless you are a qualified technician and have authority in writing from AERL to do so.
- AERL will not be held responsible in any way for the mishandling of this product or for installation of the product in a manner that does not follow the instructions in this manual.

1 PRODUCT WARRANTY

1. AERL warrants that the Product will be free from manufacturing defects for a period of 24 months from the date of dispatch of the products by AERL to the customer.
2. The Products technical specifications are contained within the Product Datasheet and User Manual. The Product will conform to the technical specifications contained in the Product Datasheet and User Manual at the time of dispatch of the Products to the Customer. If the technical specifications as contained in the Product Datasheet and User Manual are not met, AERL will repair, replace the Product, or refund the amount paid by the Customer in relation to the Product at the Customers option. AERL is under no obligation to provide assistance or advice to the Customer in relation to the technical specifications.
3. The Products must be installed in strict accordance with the Installation Recommendations listed in this User Manual.
4. In no event will AERL be liable for:
 - a) any loss or damage which the Customer suffers arising from, or caused or contributed to by, the Customer's negligence or the negligence of the Customer's agents or servants; and
 - b) special, indirect or consequential loss or damage as a result of a breach by the Customer of these Standard Terms including, without limitation, loss of profits or revenue, personal injury, death, property damage and the costs of any substitute Products which the Customer obtains.
5. The Product is not covered for damage occurring due to water, including but not limited to condensation, moisture damage and other forms of precipitation.
6. The Product is not covered for damage occurring due to the Product being incorrectly installed or installed in a manner not in accordance with the Installation Recommendations listed in the Product User Manual.
7. The Product is not covered for damage occurring due to failure on the part of the customer to operate the product in accordance with the technical specifications as listed in the Product Datasheet.
8. The Product is not covered for damage occurring due to lightning.
9. The Product is not covered for situations where it is used in a manner not specifically outlined in the Product Manual.
10. If any provision in this document is invalid or unenforceable this document will remain otherwise in full force apart from such provision, which will be deemed deleted

Disclaimer:

Australian Energy Research Laboratories Pty Ltd, its affiliates, agents, and employees, and all persons acting on its or their behalf (collectively, "AERL"):

- a) Disclaim any and all liability for any errors, inaccuracies or incompleteness contained in any datasheet or in any other disclosure relating to any product
- b) Assumes no responsibility or liability for loss or damage whether direct, indirect, consequential or incidental, which might arise out of use of such information. The use of any such information will be entirely at the user's risk.
- c) Reserves the right to change any AERL product, product specifications and data without notice to improve reliability, function or design or otherwise.

Notice of Copyright

AERL COOMAX SR MPPT Solar Charge Controller User Manual Copyright © 2013 all rights reserved. AERL reserves the right to revise this document and to periodically make changes to the content.

1.1 PRODUCT SPECIFICATIONS

CHARACTERISTIC	SRMVW	SRHWV
Nominal Battery Voltage - Selectable	24 to 84V	48 to 132V
Maximum Output Current	60A	45A
Maximum Recommended PV Array	5000W @ 84Vout(nom) 3800W @ 60Vout(nom) 3000W @ 48Vout (nom) 1500W @ 24Vout(nom)	5200W @ 132Vout(nom) 5000W @ 120Vout(nom) 4500W @ 96Vout(nom) 2300W @ 48Vout(nom)
Maximum PV Voltage Open Circuit	180V	290V
Power Conversion Efficiency	99+%	98.5+%
Battery Temperature Compensation	Yes	Yes
Operating Temperature Range	-20° to 50°C	-20° to 50°C
Remote Temperature Sensor	Included	Included
Storage Temperature	-30° to 70° C	-30° to 70° C
Self Consumption	100mA @ 20V	75mA @ 40V
Communication Protocol Options	CAN and Modbus RTU	CAN and Modbus RTU
Communication Ports	RS485 & USB	RS485 & USB
Required cabinet air exchange rate (intake at 40°C)	40 m ³ /hour	40 m ³ /hour
Operating temperature of heatsink at full rated power	35°C temperature rise	35°C temperature rise
Cable entry conduit diameter	40mm	40mm
High power wire size	16mm ² Max	16mm ² Max
Enclosure type	Indoor Type1	Indoor Type 1
Weight	3.7kg	3.7kg
Outer dimensions (L x W x H)	356 x 133 x 104 mm	356 x 133 x 104 mm
Languages (other language updates to come)	English	English

2 OVERVIEW

The AERL COOLMAX SR is a high efficiency, buck only, common positive Maximum Power Point Tracker (MPPT). It is the latest development in the MAXIMIZER range, which was pioneered by AERL in 1985. The COOLMAX SR blends the famously reliable AERL power stage with easy to use digital features such as system performance logging, fully configurable alarms and remote system monitoring and control.

The COOLMAX SR employs a maximum power point tracking strategy which has been proven to be highly robust, resistant to local extremes, and results in power losses of less than 0.5% over the whole operating temperature range of a PV Array.

Some of the device's key features include:

- Increase PV output by up to 35%
- Super high conversion efficiency > 99%
- Common positive wiring configuration
- Highly advanced colour touch screen LCD display
- Modbus, CAN bus and standard USB interface
- High power density — 1kW/l & 1.5kW/kg

2.1 WHY USE AN MPPT?

In simple terms, a Maximum Power Point Tracker sets the voltage of the solar panels to the ideal operating point of the panels. This is the maximum power voltage, or the voltage at which the solar cells can deliver maximum power to the load. This means that by using MPPT technology, the COOLMAX SR can harvest up to 35% more energy from a solar array compared to a non-MPPT charge controller.

The bottom line for solar system installers is that a cheaper, less powerful solar array can always be installed when using an MPPT – this saves cost, wiring and solar area. Because the MPPT can boost the panel's output by up to 35%, the required array size and cost is reduced.

The other benefit of MPPT converters is that a high voltage solar array can be converted down to a low voltage battery pack. This is advantageous because solar arrays are designed to be wired in series, and require much lighter wire when doing so. Additionally, a low voltage battery pack is substantially safer than a lethal, high voltage pack.

3 INSTALLATION



Important

The COOLMAX SR must be installed in a clean and dry location away from direct sunlight.

Best cooling is achieved when the COOLMAX SR is mounted vertically against a wall with a clear open area at the top of the unit. At least 20cm should be kept clear above the COOLMAX SR to allow free air flow.

3.1 MOUNTING

The COOLMAX SR should be fixed to a vertical surface using M5 screws through the 8 mounting holes in the chassis as seen below in **Fig.1**.

All dimensions in mm.

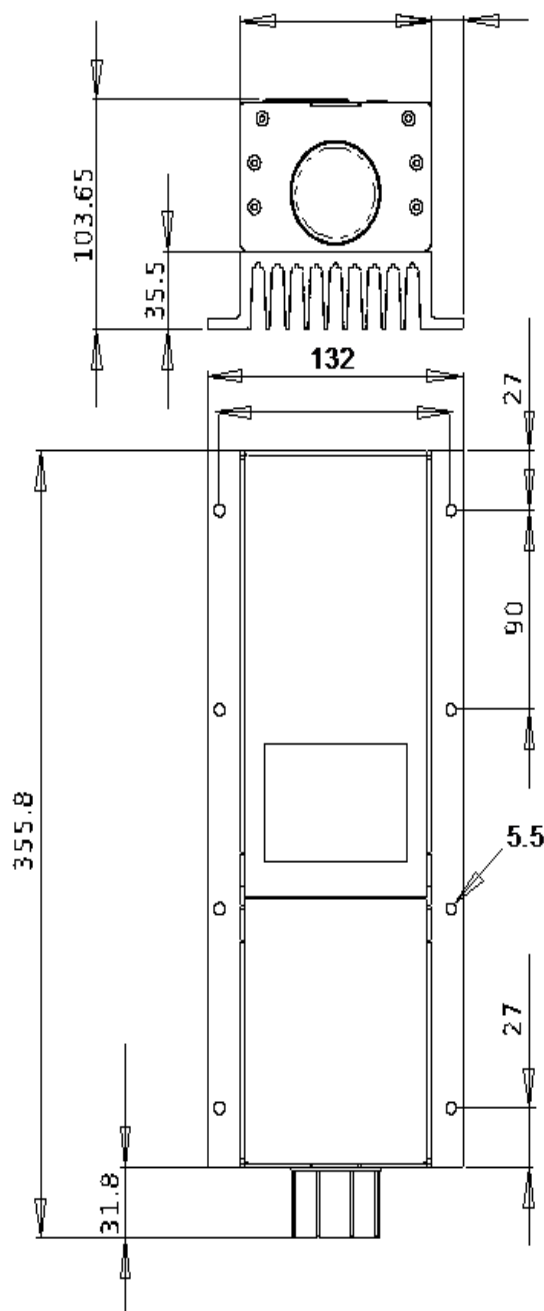

Figure 1: Mounting Holes

4 WIRING

All COOLMAX SR wiring must enter the unit via a 40mm conduit fitting at the bottom of the unit. Remove the access cover at the bottom of the COOLMAX SR to install the cabling. This is done by removing the two M3 countersunk hex screws on the bottom of the enclosure at the front as shown below in **Fig. 2**.

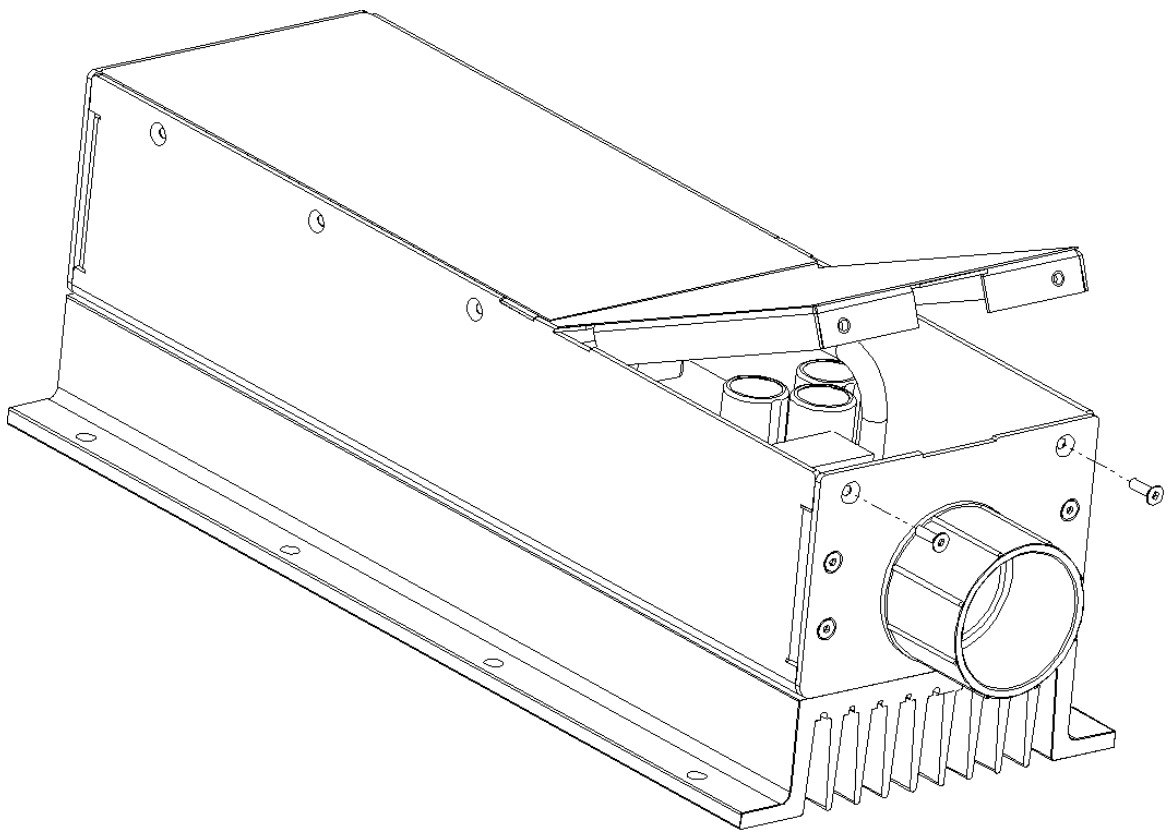

Figure 2: Removal of the Access Panel

With the access cover removed, three terminal blocks should be visible. The left most terminal block (**J1**) is for the alarm output, remote shutdown input, and temperature compensation. The terminal block (**J3**) on the right is for the Controller Area Network (CAN). The central terminal block (**J2**) is for power in and power out. Figure 3 below shows the PIN-outs for these terminals.

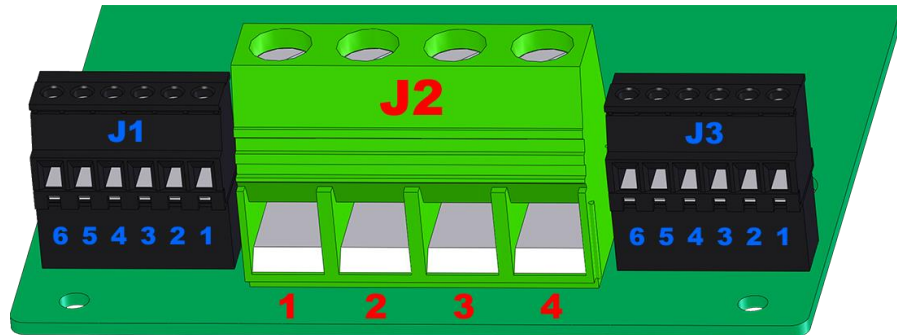

Figure 3 - Terminal Board PIN-out (Looking into Access Port)

Signal PIN Assignment

PIN	Assignment	Type	Functional Description	Isolated
J1-1	GND	Analogue input	Temperature compensation thermistor	NO
J1-2	TMPCMP			
J1-3	GND	Digital input	Pull these lines together to disable output of the COOLMAX SR	NO
J1-4	ON/OFF			
J1-5	Alarm NO	Clean contact output	Will close when an alarm is active	YES - 1000V
J1-6	Alarm COM			
J2-1	PV IN-	PV PWR IN	Refer to Product datasheet for the current and voltage limitations	NO
J2-2	PV IN+			
J2-3	BATT OUT +	BATT PWR OUT	Refer to Product datasheet for the current and voltage limitations	NO
J2-4	BATT OUT -			
J3-1	CAN +12V	Output power	Power for the CAN bus	YES
J3-2	CAN GND			
J3-3	SHIELD	Digital IO	CAN signals	YES
J3-4	CAN H			
J3-5	CAN L			
J3-6	NC			

Table 1 - Signal PIN Assignment

5 CIRCUIT BREAKERS

AERL recommends the use of 6kA, 8kA or 10kA DC rated circuit breakers with an appropriate voltage rating on both input and output. Double or triple ganged circuit-breakers can be connected in series to give the desired voltage rating as shown in the example configurations below in **Figure 4**.

It is important that the peak voltages are taken into account when selecting breakers. For example, a 120V nominal battery pack will be close to 150V at top of charge, so the breaking capability of the circuit breakers will need to be selected accordingly.

It is important to note that the COOLMAX SR attempts to process all available power from the PV array and therefore the output current from the UNIT increases with decreasing output voltage. At a low enough output voltage, the current will exceed the COOLMAX SR's over current trip point and shut-down in order to protect itself. In the COOLMAX SR MV unit, this trip point is 72A and in the COOLMAX SR HV it is 55A. This implies that a PV panel rated to produce the COOLMAX SR's maximum battery charge current at nominal battery voltage will shut-down due to over current if the battery voltage falls below 1.7V per cell.

The implication of the COOLMAX SR'S behaviour described above is that an 80A rated circuit breaker should be used for the COOLMAX SR MV and a 63A rated breaker should be used for the COOLMAX SR HV.

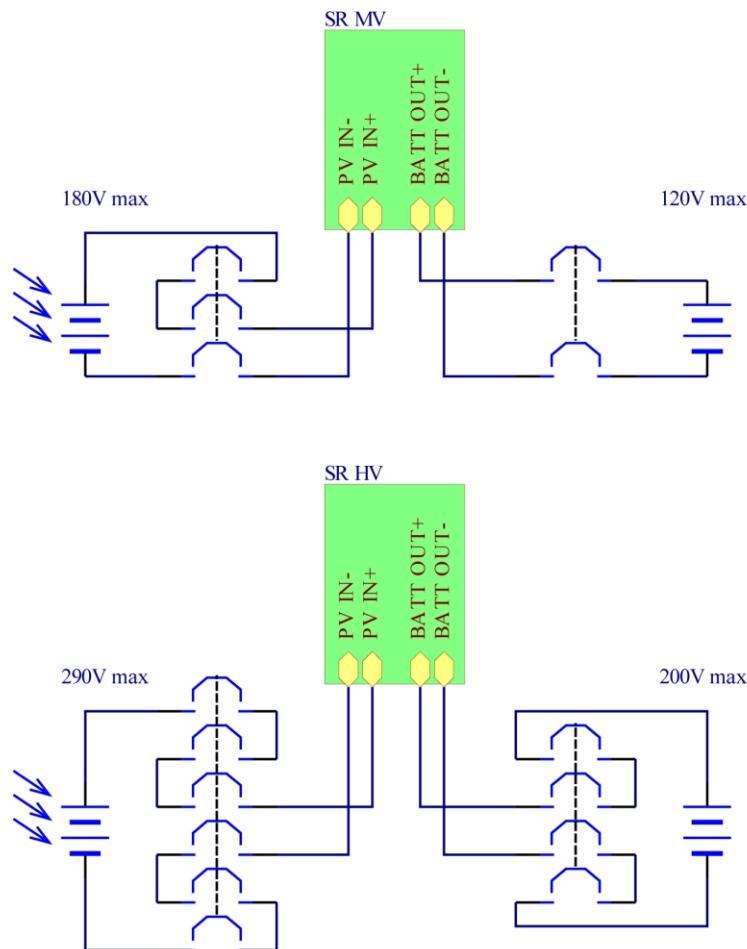

Figure 4 - Example breaker configuration for both the MV and HV COOLMAX SR assuming 60V rated DC breakers

6 EARTHING



Equipment Damage

The chassis of the COOLMAX SR should be earthed by installing an earthed ring terminal under the bottom left mounting bolt of the chassis. **DO NOT EARTH THE ARRAY** in any way IF a negative earth is used for the batteries or DC system.

AERL recommends that the COOLMAX SR be utilized in a floating system (no earthing to the power terminals) whenever possible. For very exposed systems, it is recommended that a lightning conductor be provided nearby to prevent damage to PV equipment, batteries and the COOLMAX SR.

For systems using SunPower PV arrays, it is necessary to provide a positive earth for the array.

6.1 CONNECTIONS

Use only appropriately rated wire to connect PV input and battery bank output. Check the polarity in the diagram provided in this User Manual.



Reversing polarity of either the input or the output will cause damage to the COOLMAX SR

Install circuit breakers as described in Section 5 - Circuit Breakers.

Check the polarity of the input and output with a multimeter before closing the breakers.

7 LCD FAULT CODES

If the COOLMAX SR detects a fault, it will display a code on the LCD display, as well as illuminating the 'HOLD' symbol. The fault codes are described in the following table. Faults can be reset by disconnecting the input and output of the COOLMAX SR until the LCD display switches off.

Fault Code	Fault	Description
1	Negative PV Current	Current was detected flowing into the PV array.
2	High PV Current	PV current high enough to damage COOLMAX SR.
4	High PV Voltage	PV voltage high enough to damage COOLMAX SR.
8	High Battery Current	Battery current high enough to damage COOLMAX SR.
16	High Battery Voltage	Battery voltage high enough to damage COOLMAX SR.
32	High Temperature	Heat-sink temperature high enough to damage COOLMAX SR.
64	Fan Failure	Fan has failed to start.

Table 2 - LCD Fault Codes

If multiple faults were detected by the COOLMAX SR, the fault code displayed will be the sum of the fault codes of the individual faults. For example if high PV current and high battery voltage were detected together, the LCD display would show 18 (i.e. 2 + 16 = 18).

8 CAN COMMUNICATIONS

8.1 CAN NETWORK TOPOLOGY

Multiple COOLMAX SR units can exist on the same CAN bus and this can be connected to other networks using a CAN-Ethernet Bridge adaptor.

The CAN bus is structured as a linear network, with short stubs branching from 'T' connectors on the main bus backbone to each device. The CAN bus data lines must be terminated at each end of the main bus with 120 Ω resistors between the CAN-H and CAN-L signals.

A simple method of implementing the 'T' junction is shown in Figure 5. The in and out wire of each CAN line are twisted together and screwed into the appropriate terminal on the CAN connector, as shown in below in Figure 6. This connector plugs into J3 as shown in Figure 3 on page 9 of the manual.

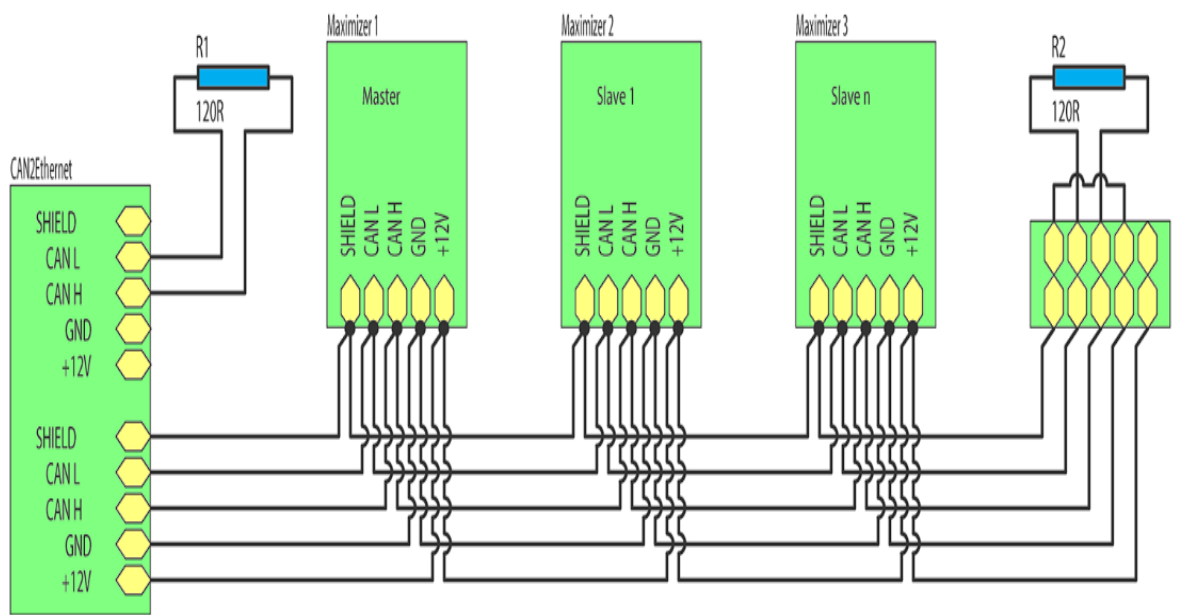

Figure 5 - CAN Network Wiring Diagram

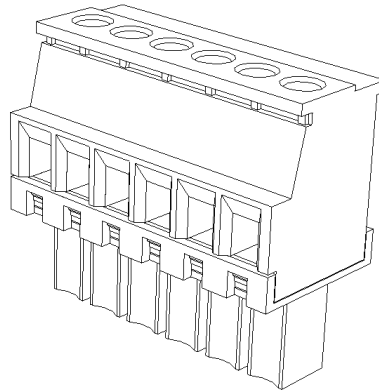

Figure 6 - CAN Connector (6-Way Screw Terminal)

8.2 CAN WIRING

The CAN data lines (CAN-H and CAN-L) must be implemented with twisted-pair wire for proper data integrity. The wire should have a characteristic impedance of 120 Ω .

Power should also be provided along the CAN cable, ideally with another twisted pair to minimise noise pickup. An overall shield can also be advantageous.



The recommended choice of cable is 7mm DeviceNet CAN-Bus 'thin' cable, with 24 AWG (data) + 22 AWG (power) twisted pairs and a braided shield. Using this cable will result in a robust installation.

Standard CAT5 network cabling (which has an impedance of 100 Ω) can be used, but may become unreliable in longer networks or in the presence of electrical noise from DC/DC converters and other electrical devices in the system.

8.3 SHIELDING



Correct shielding practice is important for error free communications. Incorrect shielding can cause more interference than unshielded cables would experience. Shields should be linked between each wire segment along the network but only grounded in one place. The following paragraphs explain how to achieve this.

The shield should be wired through the entire network independently of the ground and connected to ground at the end of the network and nowhere else in the network. This is shown below at the right hand end of the example network in **Figure 5**.

8.4 CAN TERMINATION

A 120 Ω resistor needs to be wired between the CAN-H and CAN-L lines at either end of the linear network in order to terminate both ends of the network. At the far end of the network the resistor can be simply installed into the last terminal block.

If no CAN-Ethernet Bridge adapter is present on the network the same terminal block style termination can be made on the other end of the network. However, if a CAN-Ethernet Bridge adapter is present on the network, it can be used to terminate the network by wiring a termination resistor across CAN-H and CAN-L on the unused header.

8a MODBUS COMMUNICATIONS

8a.1 MODBUS NETWORK TOPOLOGY

Multiple COOLMAX SR units can exist on the same Modbus and this can be connected to other networks using a Modbus-Ethernet Bridge adaptor.

The Modbus is structured as a linear network, with short stubs branching from 'T' connectors on the main bus backbone to each device. The Modbus data lines must be terminated at each end of the main bus with 120 Ω resistors between the Modbus-A and Modbus-B signals.

A simple method of implementing the 'T' junction is shown below in **Fig.7**. The in and out wire of each Modbus line are twisted together and screwed into the appropriate terminal on the Modbus connector, as shown in **Fig.9**. The Modbus connector is then connected into the COOLMAX SR as shown in **Fig.10**.

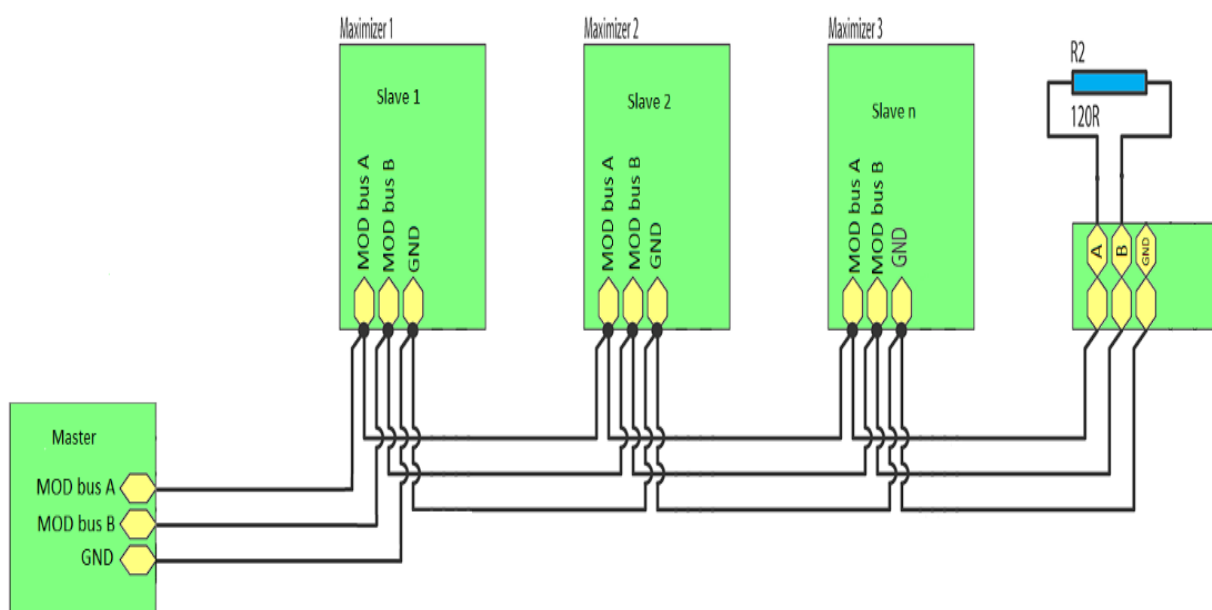

Figure 7 – Modbus Wiring Diagram

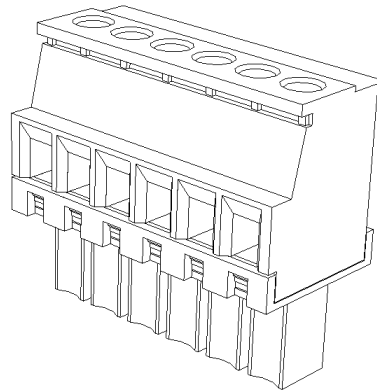

Figure 8 – Modbus Connector (6-Way Screw Terminal)

8a.2 MODBUS WIRING

The Modbus data lines (Modbus-A and Modbus-B) must be implemented with twisted-pair wire for proper data integrity. The wire should have a characteristic impedance of 120 Ω.

Power should also be provided along the Modbus cable, ideally with another twisted pair to minimise noise pickup. An overall shield can also be advantageous.



The recommended choice of cable is 7mm DeviceNet Modbus 'thin' cable, with 24 AWG (data) + 22 AWG (power) twisted pairs and a braided shield. Using this cable will result in a robust installation.

Standard CAT5 network cabling (which has an impedance of 100 Ω) can be used, but may become unreliable in longer networks or in the presence of electrical noise from DC/DC converters and other electrical devices in the system.

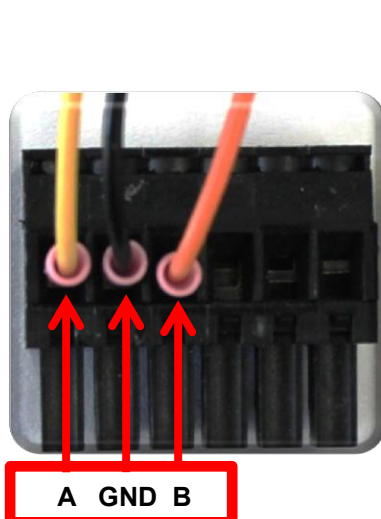

Figure 9 – Modbus Connector

Modbus Connector Socket

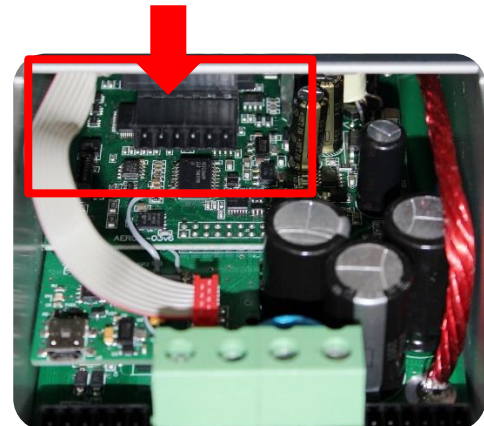

Figure 10 – Modbus Connector Socket

8a.3 SHIELDING



Correct shielding practice is important for error free communications. Incorrect shielding can cause more interference than unshielded cables would experience. Shields should be linked between each wire segment along the network but only grounded in one place. The following paragraphs explain how to achieve this.

The shield should be wired through the entire network independently of the ground and connected to ground at the end of the network and nowhere else in the network. This is shown at the right hand end of the example network in **Fig.7**.

8a.4 MODBUS TERMINATION

A 120 Ω resistor needs to be wired between the Modbus-A and Modbus-B lines at either end of the linear network in order to terminate both ends of the network. At the far end of the network the resistor can be simply installed into the last terminal block.

If no Modbus-Ethernet Bridge adapter is present on the network the same terminal block style termination can be made on the other end of the network. However, if a Modbus-Ethernet Bridge adapter is present on the network, it can be used to terminate the network by wiring a termination resistor across Modbus-A and Modbus-B on the unused header.

9 OPERATING GUIDELINES

9.1 BATTERY CHARGING SETUP

The batteries are charged using an automatic equalise / anti-sulphation charging profile. This profile is designed for lead-acid batteries, which can be equalised automatically by allowing each battery to vent for a short time.

The charge profile can be edited for other battery chemistries by manipulating the following parameters

- Bulk voltage
- Float voltage
- Bulk reset voltage
- Bulk time

Battery chemistries other than lead acid should be used with extreme caution as it is not safe to overcharge individual cells. It is always recommended to employ a battery monitoring system as an unbalanced battery pack can result in damage to batteries due to overcharging.

An example charge profile for the COOLMAX SR is shown below to illustrate the charge profile parameters above. To edit the charge profile parameters, please refer to the documentation for the COOLMAX SR communications software.

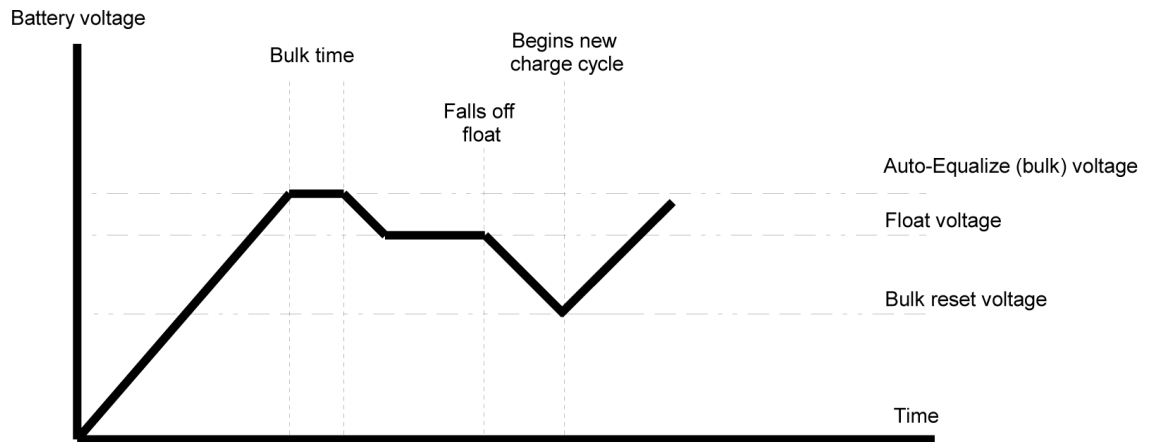

Figure 11 - Battery Charge Control Profile

9.2 TEMPERATURE COMPENSATION

Temperature compensation measures the temperature of the batteries and adjusts the float voltage set point to the ideal voltage for batteries at that temperature.

The thermistor is connected between J1-1 and J1-2 as shown in **Figure 3**. The COOLMAX SR measures the voltage between TMPCMP+ and GND to determine the temperature of the batteries.

Using the temperature of the batteries, the COOLMAX SR adjusts the float voltage by a user specified factor in millivolts per °C.



NOTE: The temperature compensation factor is adjusted using the COOLMAX SR software. Please refer to its documentation for more information.

9.3 RELAY ALARM / GENSET CONTROL

The ALARM PINs are the contacts of an isolated 12V, 1A relay. When an alarm state is in effect, ALARM will be connected inside the COOLMAX SR. When the alarm state is removed, ALARM will be completely disconnected from each other.

An external alarm or Genset control circuit can be used to sense whether ALARM is open or closed.

Many different events can be attached to the relay. These are:

- System init (system starts up after a reset or off period)
- Low output voltage warning
- Low output voltage fault
- Low output voltage Genset start
- High output voltage fault
- High output current fault
- High discharge current fault
- Input breaker open
- Output breaker open

- Temperature sensor fault
- Regulation fault
- Log file full
- Panel missing

These are configurable so that multiple faults could trigger the relay. There is also a time hysteresis which prevents the relay from triggering on spurious readings.

To configure the events, consult the documentation for the COOLMAX SR software.

9.4 REMOTE ON/OFF CONTROL

The remote ON/OFF control can be implemented with a single switch connected between the ON/OFF PIN and GND PIN.

The COOLMAX SR will sense if the ON/OFF PIN has been connected to GND when the switch closes and this will disable the unit.

9.5 MAXIMIZER STARTUP

The COOLMAX SR electronics will begin to run when either the input or output is connected with a voltage above the start-up voltage listed in the datasheet. CAN communications can be used whenever the COOLMAX SR is powered up.

10 ADJUSTING THE CHARGE PROFILE

10.1 REAL TIME

When the COOLMAX SR Unit is first powered on, the Real Time Screen (see Fig.12) is the first screen to appear. The Real Time screen displays all the telemetry information relevant to the COOLMAX SR Unit and is the starting point from which all other COOLMAX SR screens are accessible.



Important: The COOLMAX SR unit typically requires a Battery or PV voltage above 40 volts to be able to power on

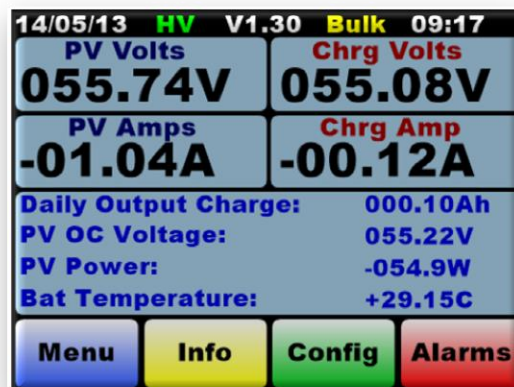

Figure 12 - Real Time Screen

10.2 MAIN MENU

To access the Main Menu Screen press the Menu Button that is at the bottom left of the Real Time Screen (Fig.12). This will go the Main Menu Screen (Fig.13) from which the Settings, Info and Alarms screen can be accessed.

To go back to the Real Time Screen (Fig.12) from the Main Menu Screen (Fig.13) press the Back Button at the top left of the Menu Screen. This will go back to the Real Time Screen.

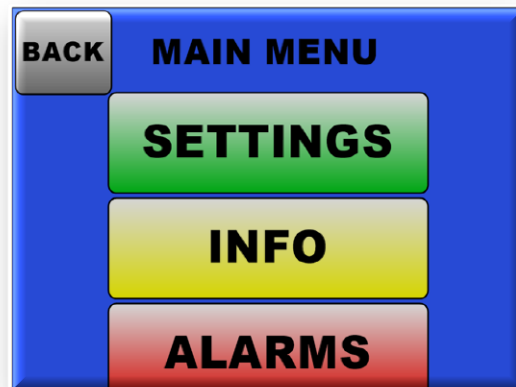

Figure 13 - Main Menu Screen

10.3 SETTINGS

From the Main Menu (Fig.13) press the Settings Button, this will go the Settings Menu screen (Fig.14) from where the various set points can be edited. The Settings Screen can also be accessed from the Real Time Screen (Fig.12) by pressing the Green Config Button at the bottom of the screen.

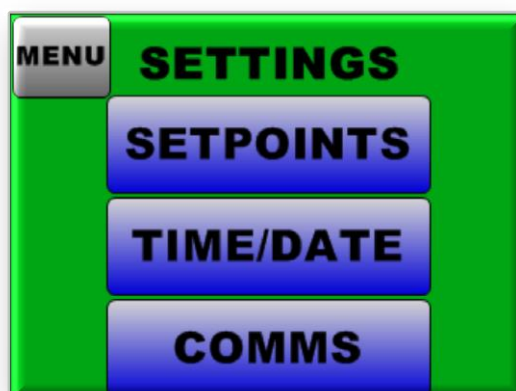

Figure 14-Settings Menu Screen

10.4 SET POINTS

The Set Points Screen (Fig.15) allows the user to modify the factory settings of the COOLMAX SR to customise the unit for a particular Solar Array and Battery Bank configuration. To scroll through the various Set Points on Page 1 and 2, press the Up or Down Buttons at the bottom of the screen. This will enable the user to scroll up or down through the various Set Points and also be able to move from Page 1 to Page 2 (Fig.15 & 15A).

To Edit the selected Set Point press the Edit Button at the bottom left of the screen. This will go to a PIN Code Entry Screen (see Fig:16) where a 4 Digit PIN Code has to be entered.

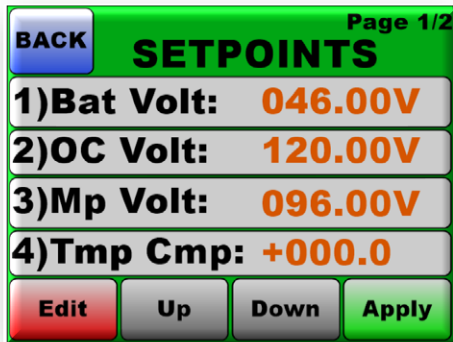

Figure 15 – Set Points Screen

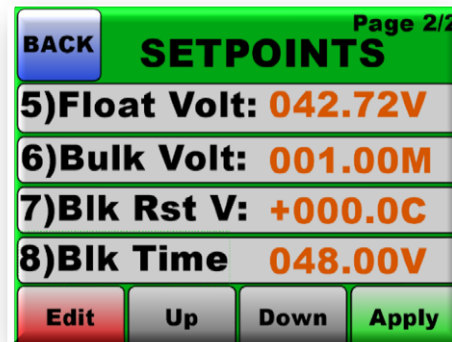

Figure 15A – Set Points Screen

10.5 PIN CODE

The PIN Code screen (Fig.16) requests the user to input a 4 digit PIN Code before any set point data can be edited. This ensures that only authorised personnel can edit the set point data. Once the 4 digit PIN Code has been entered press the Enter Button and this will allow access to the relevant set point screen that needs to be edited. If a mistake is made while entering the PIN Codes press the Delete Button to re-enter the number again. Unauthorised users who access this screen should immediately press the Delete Button to exit back to the Set Points screen.

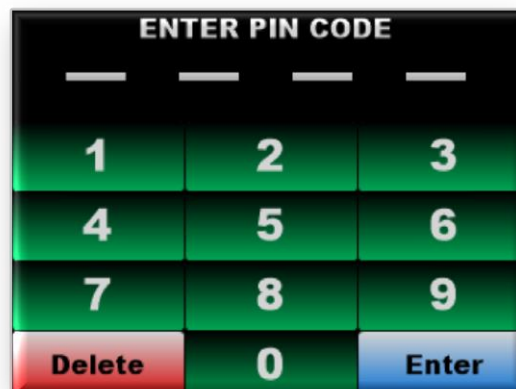

Figure 16 - PIN Code Entry Screen

10.6 SET POINT EDIT

Once the 4 Digit PIN Code has been entered correctly (Fig.16) the relevant data to be edited will appear (Fig.17). To scroll between the digits to be edited, press the Next Button. To increase or decrease the digit press the Up and Down Button. Once the relevant digits have been edited, press the Accept button to return to the Set Point Screen (Fig:15)

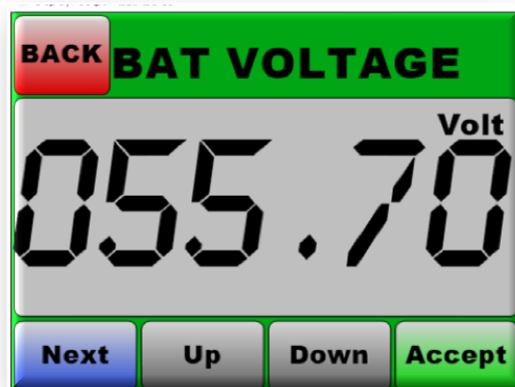

Figure17- Set Point Edit Screen

10.7 EDITING OC VOLTAGE SET POINT

The following steps illustrate the correct procedure to modify the OC Voltage Set Point to customise the unit.

Step 1

Once the unit has been powered up and the Real Time Screen (Fig.18) appears, Press the Menu button to go the Main Menu Screen (Fig18). From the main Menu Screen (Fig.18A) press the Settings button to go to the Settings Screen. (Fig.18B)

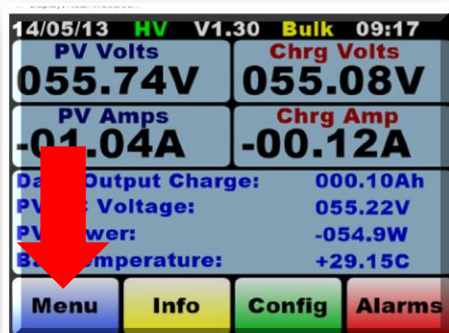

Figure 18 – Real Time Screen



Figure 18A – Main Menu Screen



Figure 18B – Settings Screen

Step 2

On the Settings Screen (Fig.18B) press the “SETPOINTS” Button to go the Set Points Screen (Fig.19). On the Set Point Screen (Fig.19) select the OC Volt Set Point by pressing the Down Button. Then press the Edit Button which goes to the PIN Code screen (Fig.20) where a 4 Digit PIN Code has to be entered.

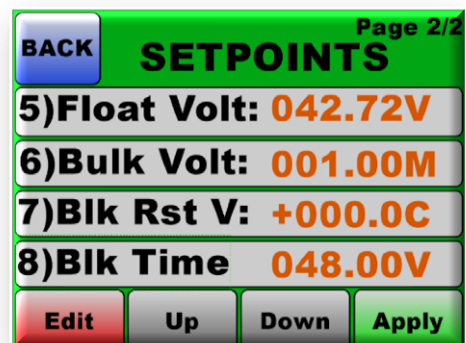
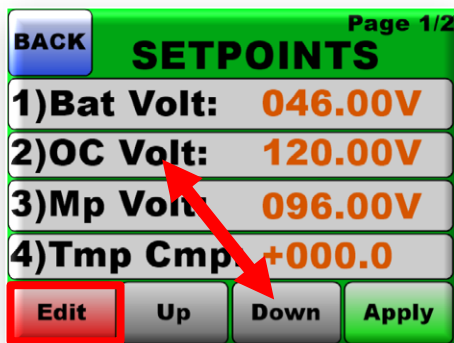

Figure 19 – Set Points Screen

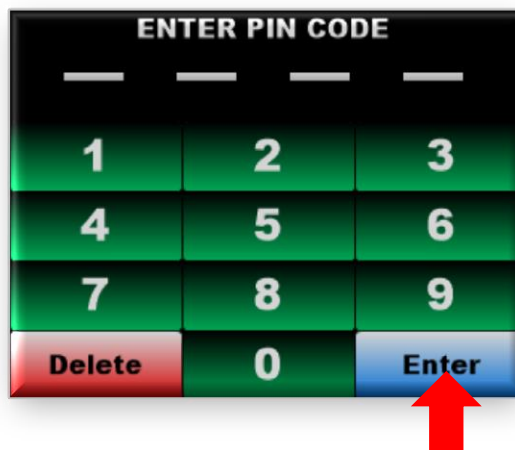

Figure 20 – PIN Code Entry Screen

Step 3

Once the 4 Digit PIN Code has been entered in the PIN Code Entry Screen (Fig.20) press the Enter Button which would then go to the Set Point Edit Screen (Fig.21) where the Set Points can be modified. To move between the various digits on the Set Point edit screen press the Next Button and to Increase or Decrease the digits press the “UP” and “Down Button”. Once the required digits have been entered press the “Accept” Button which would go back to the Set Points Screen. .

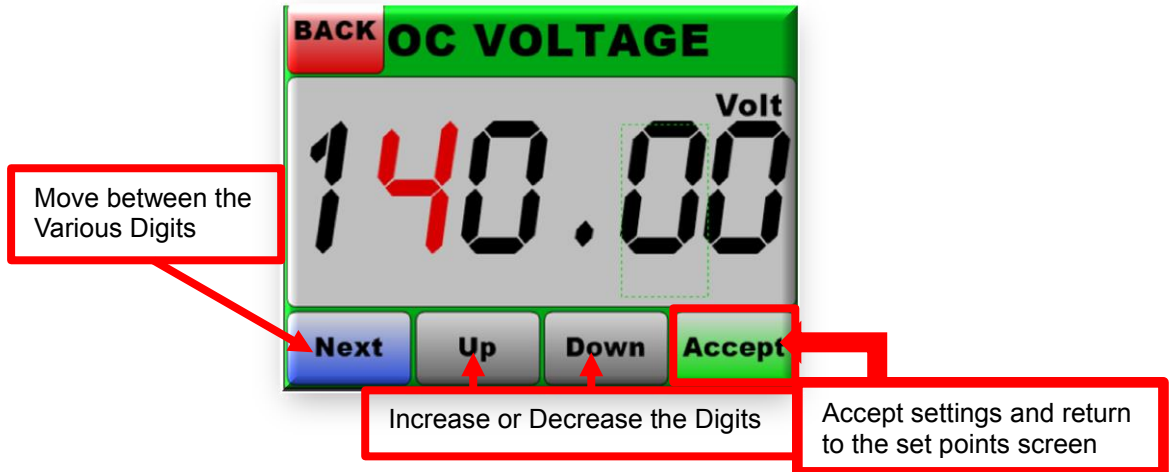

Figure 21 – Set Point Edit Screen

Step 4

On the Set Points Screen (Fig.22) press the “Apply” Button. If the Set Point data has been set correctly the configuration is uploaded and the progress is displayed on the notification screen (Fig.23). Once the Data has been successfully uploaded, the COOLMAX SR will initiate an auto-reset and return back to the Real Time Screen.



Note: Listen for the Fan Noise while the COOLMAX SR Unit Resets to indicate a successful reboot.

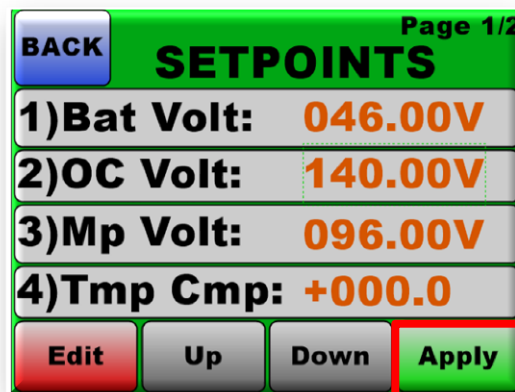

Figure 22 – Set Points Screen

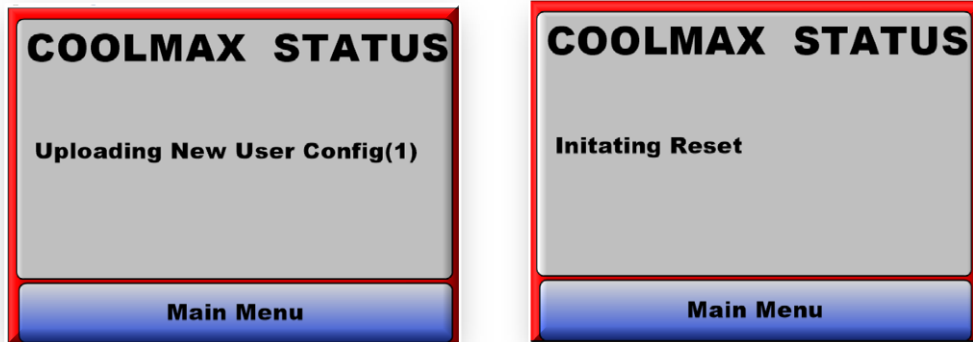

Figure 23 – Notification Screen

10.8 EDITING MP VOLTAGE SET POINT

The following steps illustrate the correct procedure to modify the MP Voltage Set Point to customise the unit.

Step 1

Once the unit has been powered up and the Real Time Screen (Fig.24) appears Press the Menu Button to go the Main Menu Screen (Fig.24A). From the main Menu Screen (Fig.24A) press the Settings Button to go to the Settings Screen. (Fig.24B)

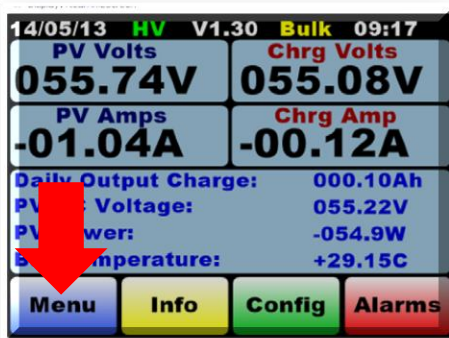

Figure 24 – Real Time Screen

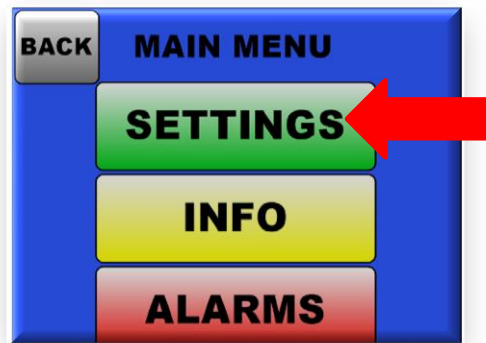

Figure 24A – Main Menu Screen



Figure 24B – Settings Screen

Step 2

On the Settings Screen (**Fig.24B**) press the Set Points Button to go the Set Points Screen (**Fig:25**). On the Set Points Screen (**Fig.25**) select the MP Volt Set Point by pressing the Down Button. Then press the Edit Button which goes to the PIN Code screen (**Fig.26**) where a 4 Digit PIN Code has to be entered.

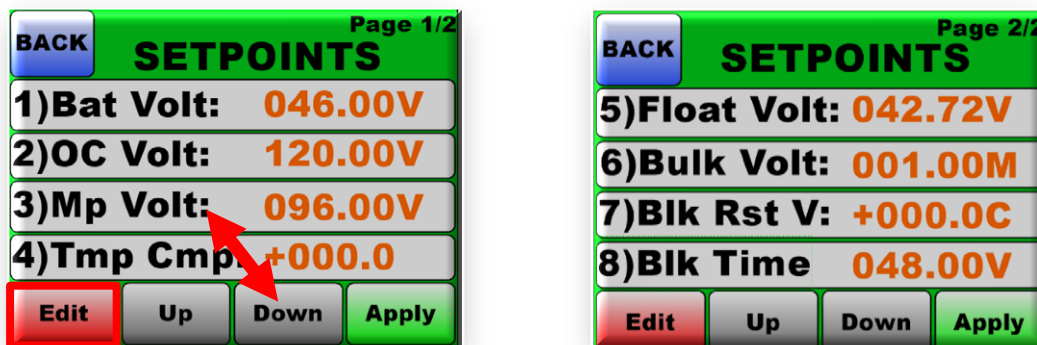

Figure 25 – Set Points Screen

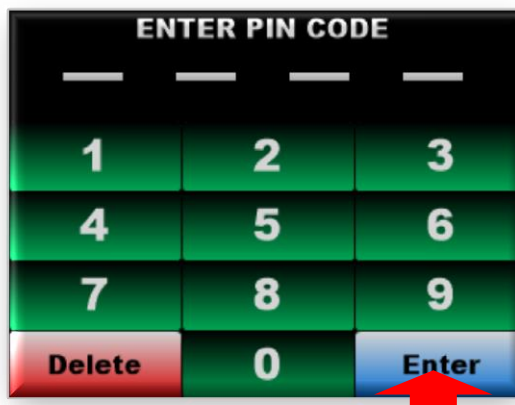

Figure 26 – PIN Code Entry Screen

Step 3

Once the 4 Digit PIN Code has been entered in the PIN Code Entry Screen (**Fig.26**) press the Enter Button which will take you to the Set Point Edit Screen (**Fig.27**) where the Set Points can be modified. To move between the various digits on the Set Point edit screen press the Next Button and to Increase or Decrease the digits press the UP and Down Button. Once the required digits have been entered press the Accept Button which would then go back to the Set Point Screen.

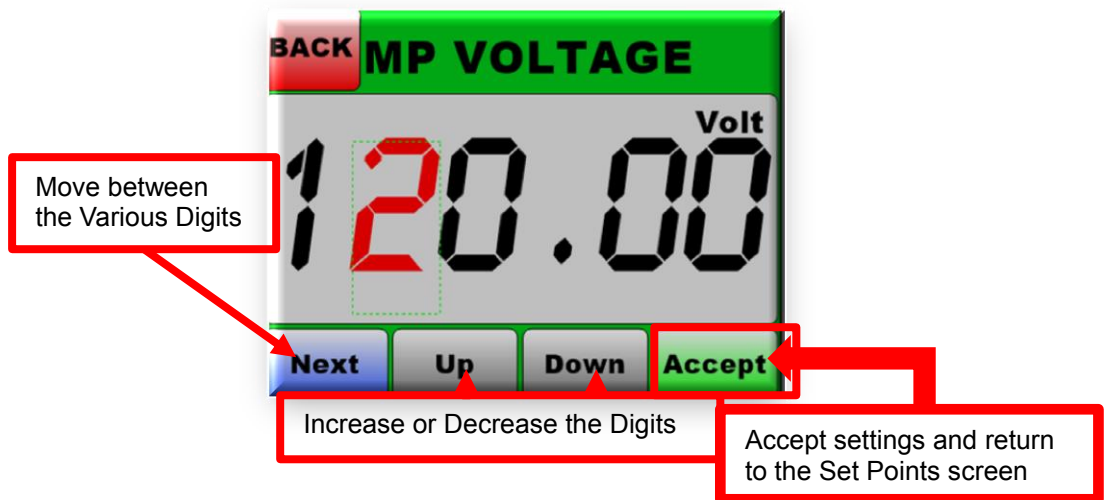

Figure 27 – Set Point Edit Screen

Step 4

On the Set Points Screen (Fig.28) press the Apply Button. If the Set Point data has been set correctly the configuration is uploaded and the progress is displayed on the notification screen (Fig.29). Once the Data has been successfully uploaded the COOLMAX SR will initiate an auto-reset and return back to the Real Time Screen.



Note: Listen for the Fan Noise while the COOLMAX SR Unit Resets to indicate a successful reboot.

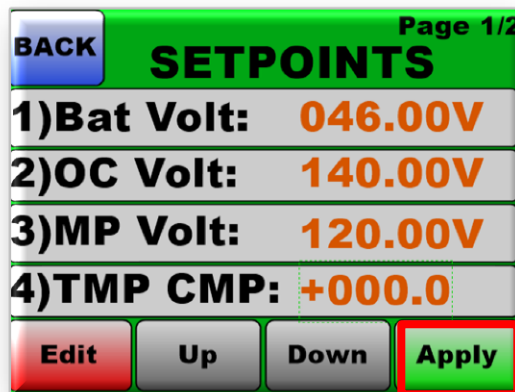

Figure 28 –Set Points Screen

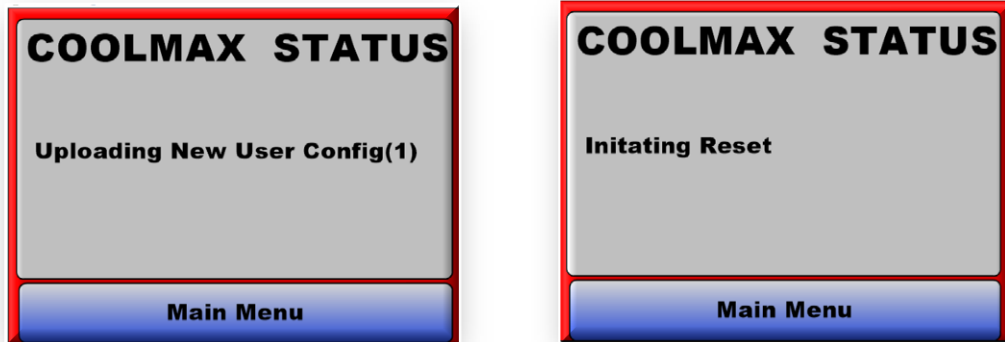

Figure 29 – Notification Screen

10.9 EDITING TMP COMP SET POINT

The following steps illustrate the correct procedure to modify the MP Voltage Set Point to customise the unit.

Step 1

Once the unit has been powered up and the Real Time Screen (Fig.30) appears. Press the Menu Button to go the Main Menu Screen (Fig.30A). From the main Menu Screen (Fig.30A) press the Settings Button to go to the Settings Screen. (Fig.30B)

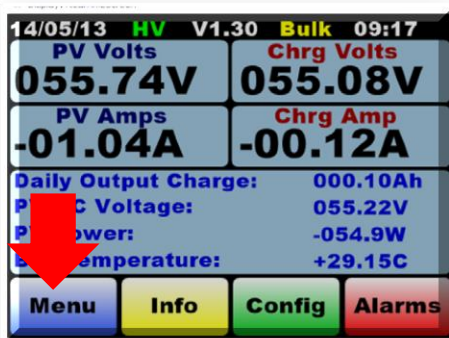

Figure 30 – Real Time Screen

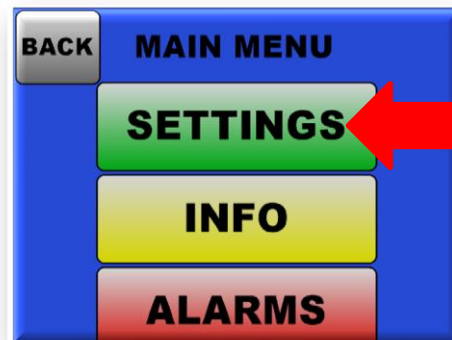

Figure 30A – Main Menu Screen

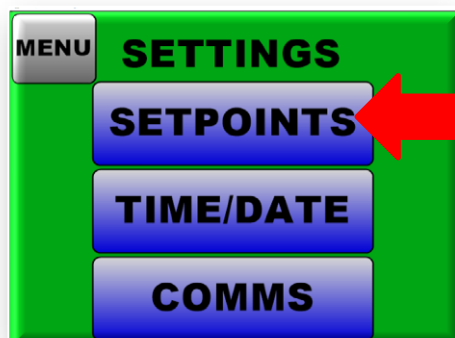

Figure 30B – Settings Screen

Step 2

On the Settings Screen (Fig.30B) press the Set Points Button to go the Set Points Screen (Fig:31). On the Set Points Screen (see Fig:31) select the Tmp Cmp Set Point by pressing the Down Button. Then press the Edit Button which goes to the PIN Code screen (Fig.32) where a 4 Digit PIN Code has to be entered.



Figure 31 – Set Points Screen

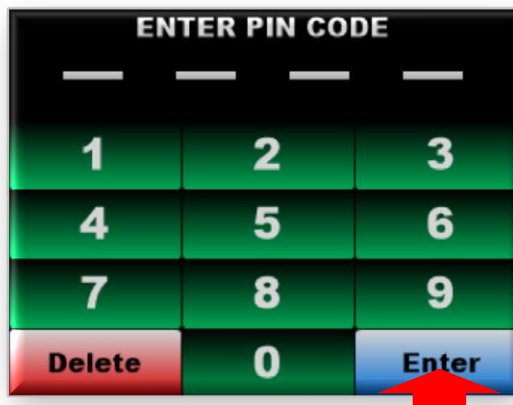

Figure 32 – PIN Code Entry Screen

Step 3

Once the 4 Digit PIN Code has been entered in the PIN Code Entry Screen (Fig.32) press the Enter Button which would then go to the Set Point Edit Screen (Fig.33) where the Set Points can be modified. To move between the various digits on the Set Point edit screen press the Next Button and to Increase or Decrease the digits press the UP and DOWN Button. Once the required digits have been entered press the Accept Button which would go back to the Set Points Screen. .

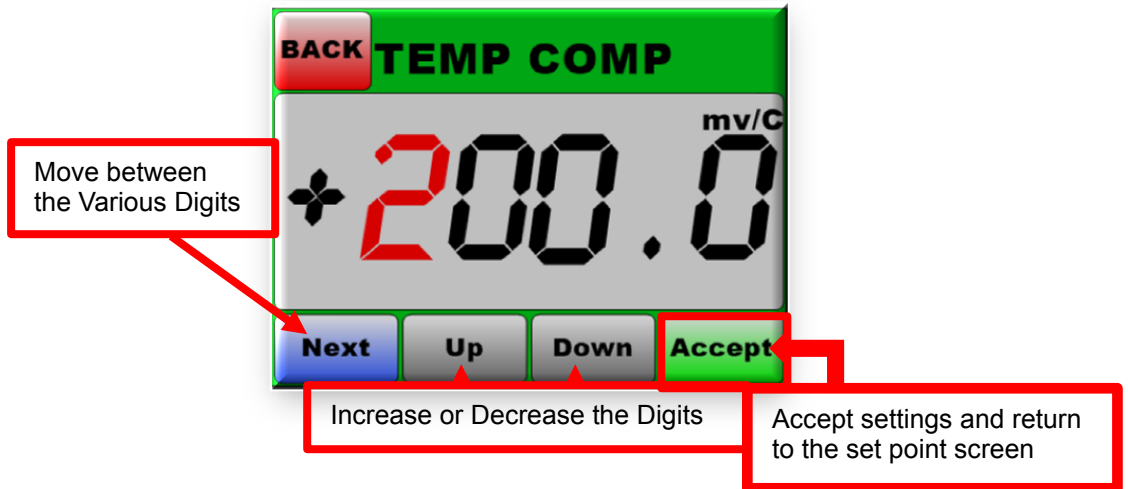

Figure 33 – Set Point Edit Screen

Step 4

On the Set Points Screen (Fig.34) press the Apply Button. If the Set Point data has been set correctly the configuration is uploaded and the progress is displayed on the notification screen (Fig.35). Once the Data has been successfully uploaded the COOLMAX SR will initiate an auto-reset and return back to the Real Time Screen.



Note: Listen for the Fan Noise while the COOLMAX SR Unit Resets to indicate a successful reboot.

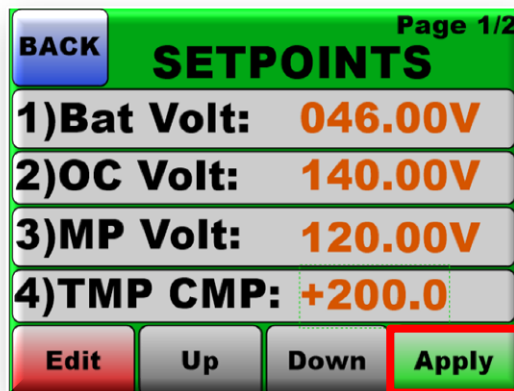

Figure 34- Set Point Screen

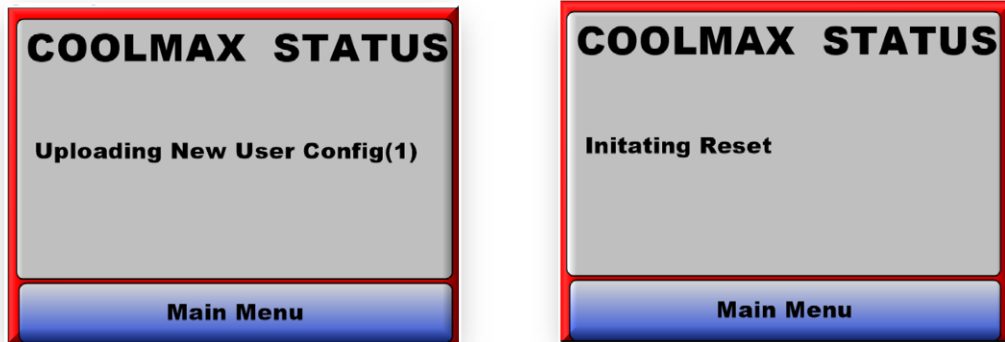

Figure 35 – Notification Screen

10.10 NOTIFICATION SCREEN

Once all Set Point data has been edited to the required values (Fig.36) Press the Apply Button at the bottom of the Set Point Screen, to load these settings into the COOLMAX SR configuration memory. The Notification Screen (Fig.37 & 37A) will be displayed to give the user information on update status of the configuration load or warning messages of the COOLMAX SR System.

When data entered on set points are above or below the allowable system parameters, a warning message is displayed (Fig.37) and the loading of the Set Point data is aborted. The user must return to the Set Points Screen to change the Set Point that was the cause of the warning message to an allowable value.

If all set point data has been set correctly the user is shown the progress of the configuration upload on the notification screen (Fig.37A), once the data is successfully uploaded the COOLMAX SR will auto-reset and return the user to the Real Time Screen. (Fig.12)

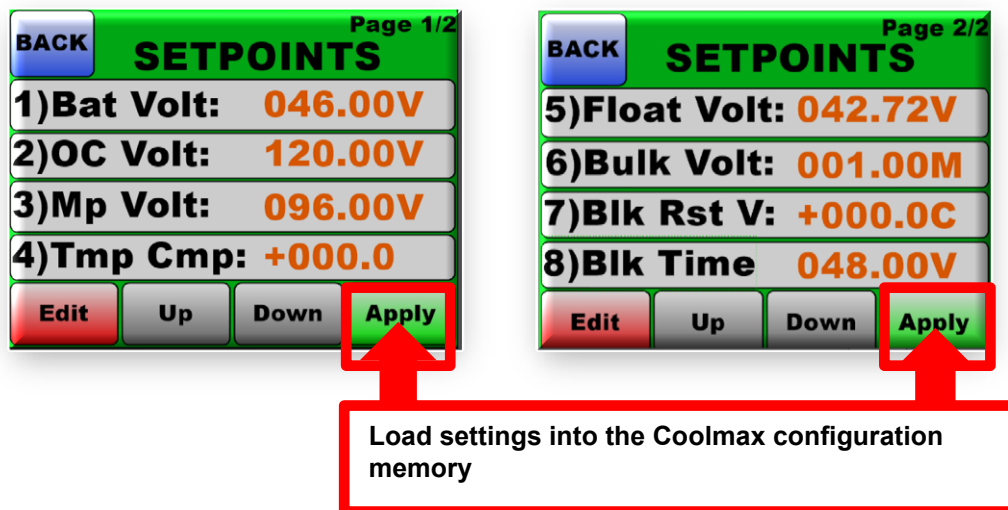

Figure 36 – Set Point Screen



Figure 37- Warning Message Screen

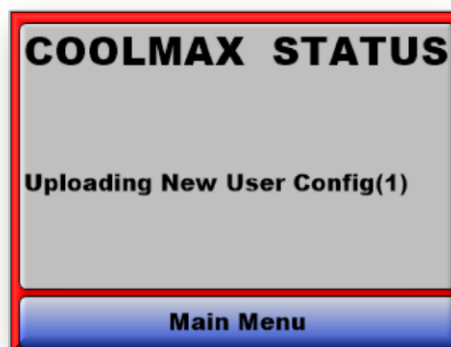

Figure 37A- Update Message Screen



Note: Listen for the Fan Noise when the COOLMAX SR Unit Reboots to indicate successful



Important

It is advisable to check if the data has been updated correctly by going back to the Set Points Screen and ensuring the recently edited data is still correct.

10.11

TIME / DATE

From the Main Menu (Fig.13) click on the Settings button. This will go to the Settings Screen (Fig.14). On the Settings Screen (Fig.14), press the Time / Date button and this will go to the Time / Date Screen (Fig.38). Press the Time Button to go to the Time Edit Screen (Fig.38A). Press the Date Button to go to the Date Edit Screen (Fig.38B).

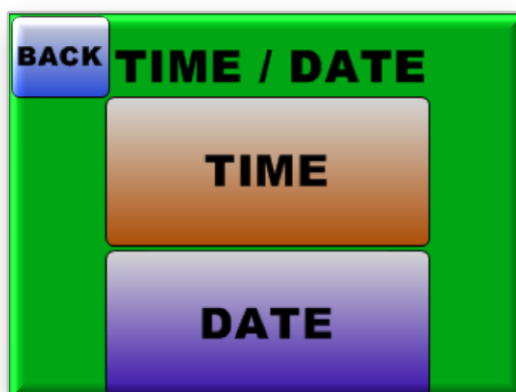

Figure 38 – Time / Date Edit Screen



Figure 38A – Time Edit Screen



Figure 38B- Date Edit Screen

10.12 EDITING THE TIME

The following steps illustrate the correct procedure to set the time for the COOLMAX SR MAXIMIZER Unit

Step 1

From the Real Time Screen (Fig.39) press the Menu Button to go to the Main Menu screen (Fig.39A). From the Main Menu Screen (Fig.39A) press the Settings Button to go to the Settings Menu screen.

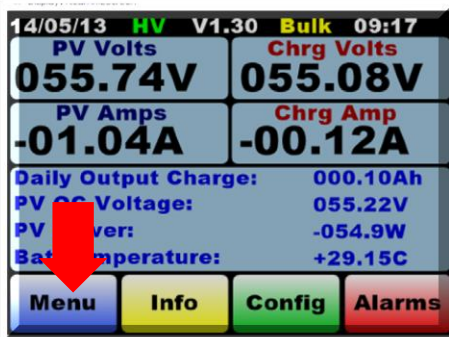

Figure 39 – Real Time Screen

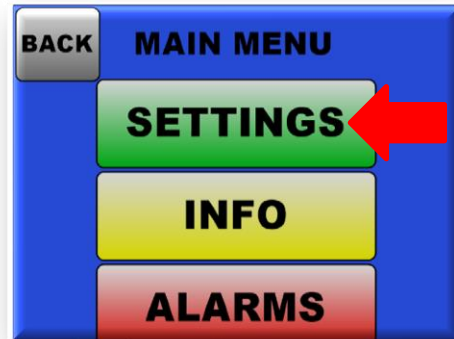

Figure 39A – Main Menu Screen

Step 2

From the Settings Menu screen (Fig.40), press the Time / Date button to go to the Time / Date screen (Fig.40A). On the Time / Date screen (Fig.40A) press the Time Button to go to the Time Edit screen

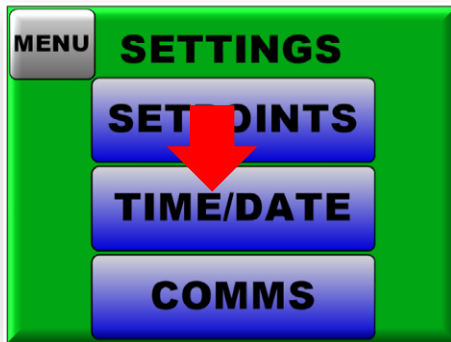

Figure 40 – Settings Menu Screen

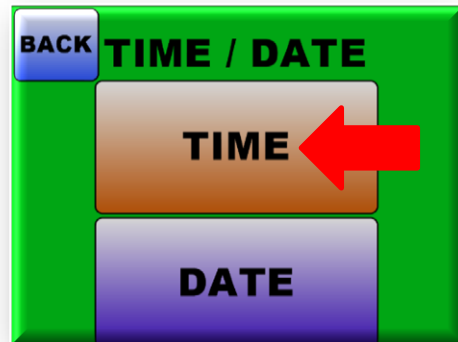

Figure 40A – Time / Date Screen

Step 3

On the Time Edit screen (Fig.41) press the Next Button to move between the various digits and the Up / Down Button to increase or decrease the Time. Once the Time has been set press the Accept Button to accept the Time and this would return back to the Time / Date screen (Fig.40A).



Figure 41 – Time Edit screen

Step 4

From the Time / Date Screen (**Fig.42**) press the Back Button to go back to the Settings Menu screen (**Fig.42A**). From the Settings Menu screen (**Fig.42A**) Press the Menu Button to go back to the Main Menu screen (**Fig.42B**). From the Main Menu (**Fig.42B**) screen press the Back Button to go back to the Real Time screen (**Fig.42C**). On the Real Time screen (**Fig.42C**) ensure the time has been set correctly on the LCD Screen.

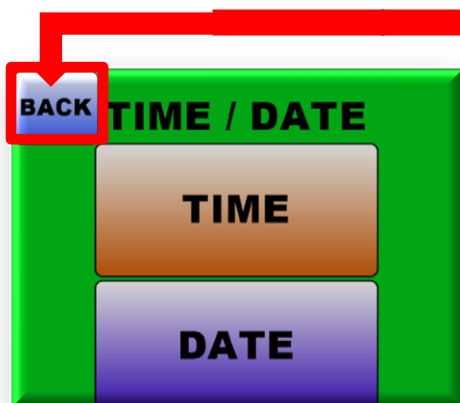

Figure 42 – Time /Date

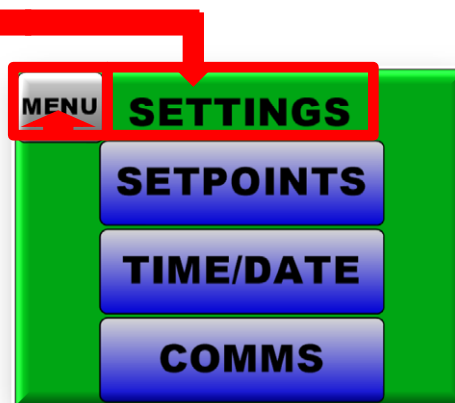

Figure 42A – Settings Menu Screen

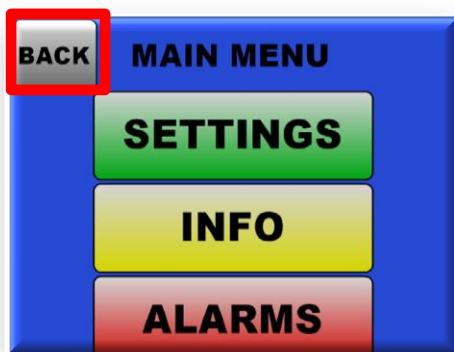

Figure 42B – Main Menu Screen

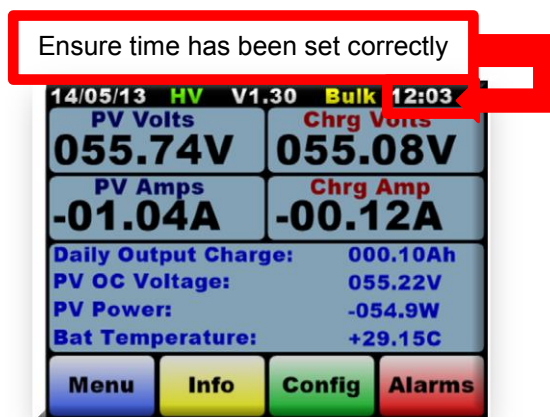

Figure 42C – Real Time Screen

10.13 EDITING THE DATE

The following steps illustrate the correct procedure to set the Date for the unit.

Step 1

From the Real Time Screen (Fig.43) press the Menu Button to go to the Main Menu screen. (Fig.43A). From the Main Menu Screen (Fig.43A) press the Settings Button to go to the Settings Menu Screen.

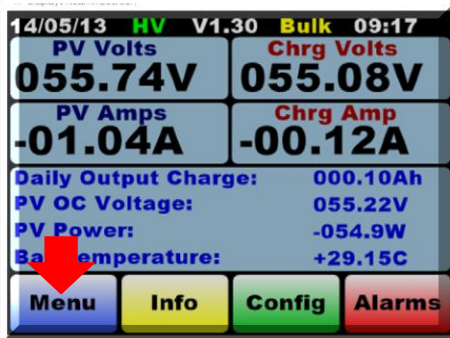

Figure 43 – Real Time Screen

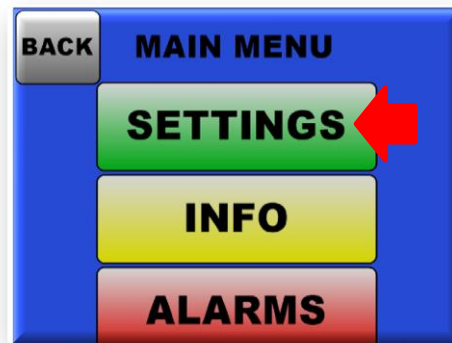

Figure 43A – Main Menu Screen

Step 2

From the Settings Menu screen (Fig.44) press the Time / Date button to go to the Time / Date screen (Fig.44A). On the Time / Date screen (Fig.44A) press the Date Button to go to the Date Edit screen.

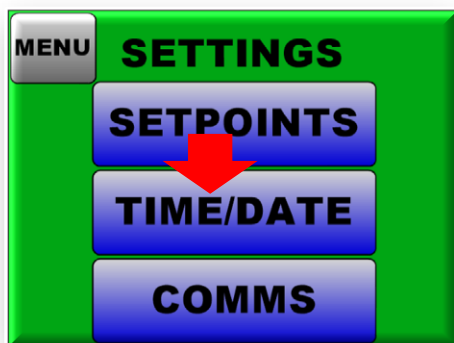

Figure 44 – Settings Menu Screen

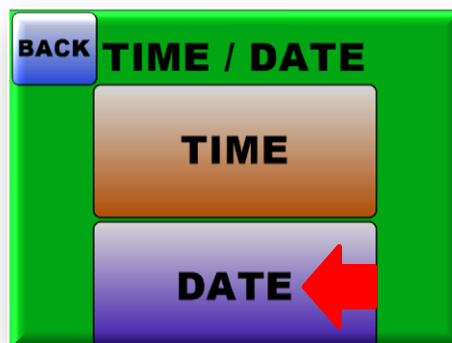

Figure 44A – Time / Date Screen

Step 3

On the Date Edit screen (Fig.45) press the Next Button to move between the various digits and the Up / Down Button to increase or decrease the Time. Once the Date has been set press the Accept Button to accept the Date and this would return back to the Time / Date screen (Fig.44A).



Figure 45 – Date Edit Screen

Step 4

From the Time / Date Screen (Fig.46) press the Back Button to go back to the Settings Menu screen (see Fig:46A). From the Settings Menu screen (Fig.46A) Press the Menu Button to go back to the Main Menu screen (Fig.46B). From the Main Menu (Fig.46B) screen press the Back Button to go back to the Real Time screen (Fig.46C). On the Real Time screen (Fig.46C) ensure the Date has been set correctly on the LCD Screen.

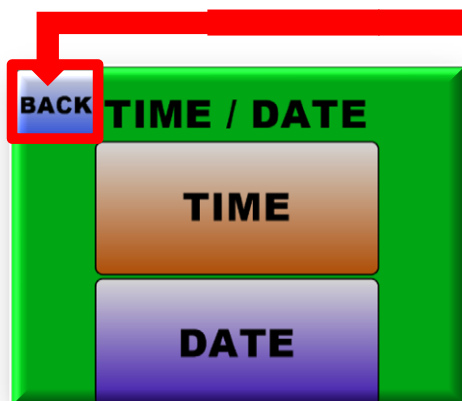

Figure 46 – Time / Date Screen

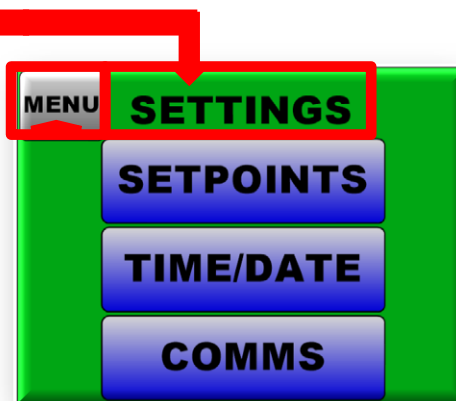

Figure 46A – Settings Menu Screen

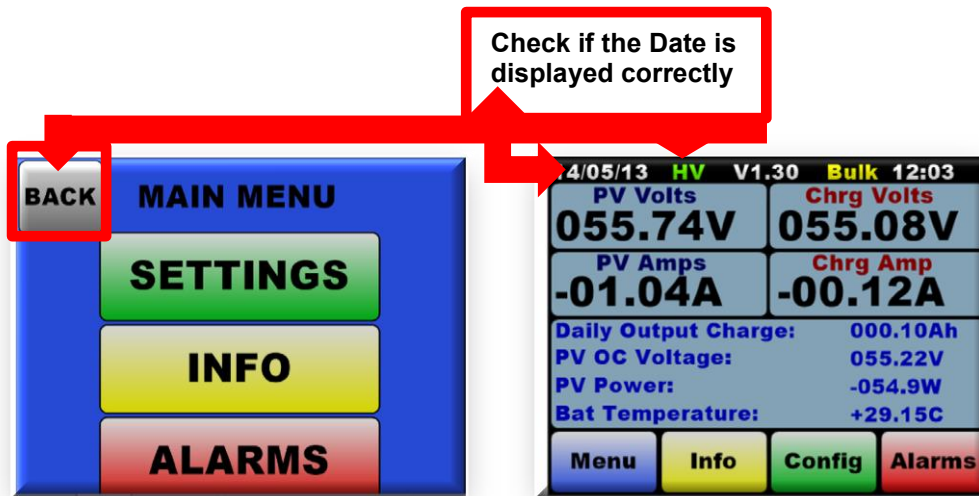

Figure 46B – Main menu

Figure 46C – Real Time Screen

10.14 COMMS INFO

The Comms / Connections Info displays all relevant information with which the COOLMAX SR Unit communicates with external devices on any network.

The Comms Info screen (Fig.47) can be accessed from the Setting's Menu (Fig.14) by pressing the Comms Button. This screen can also be accessed by pressing the Green Config Button from the Real Time Screen (Fig.12)

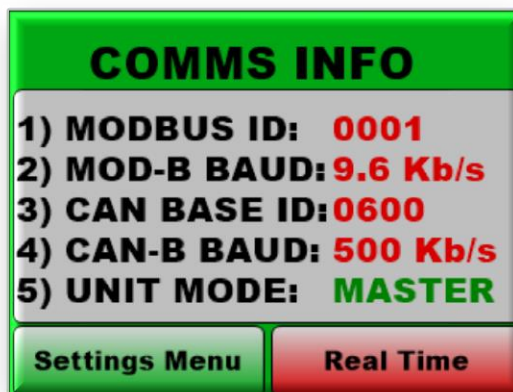

Figure 47- Comms Info Screen

10.15 UNIT INFO

From the Main Menu Screen (Fig.12) press the Info Button. This will go to the Unit Info Screen (Fig.48). The Unit Info Screen can also be accessed from the Real Time Screen (Fig.12) by pressing the Yellow Info Button.

Unit Info displays all relevant System Information relating to the COOLMAX SR Unit. The information displayed on the Info Screen page consists of:

- Serial Number
- Product Model Number
- Hardware Version
- Firmware Version
- Battery Nominal Voltage
- Status Code A (For Internal Use Only)
- Status Code B (For Internal Use Only)

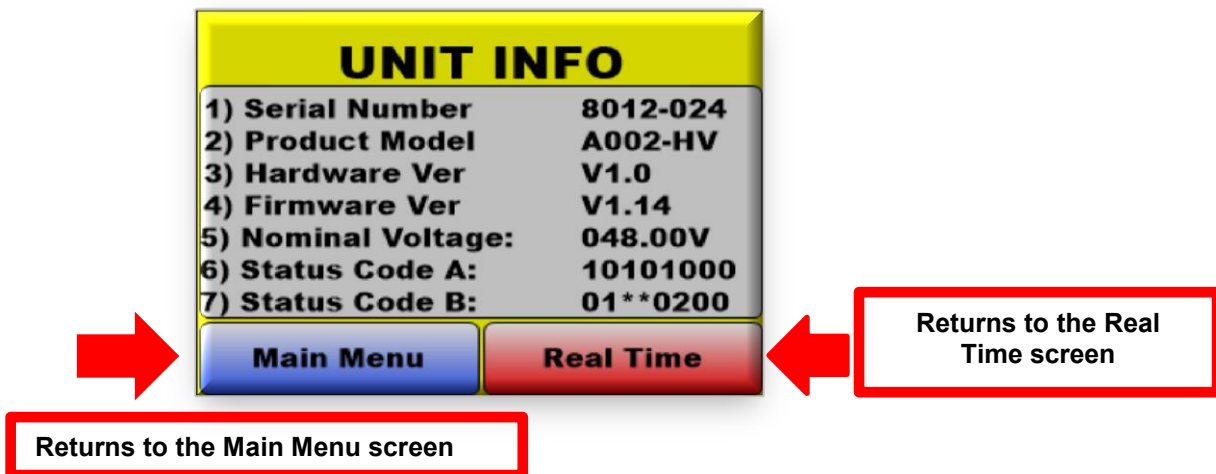

Figure 48- Unit Info Screen

To return back to the Main Menu from the Unit Info Screen press the Main Menu Button. To go back to the Real Time Screen press the Real Time button on the Info Screen page.

10.16 ALARMS / RESET

To check the status of a system alarms press the Alarms button from the Real Time Screen (Fig.12) or from the Main Menu Screen (Fig.13). This will take you to the Alarms Screen (Fig.49) where all the status of any active alarms will be displayed.

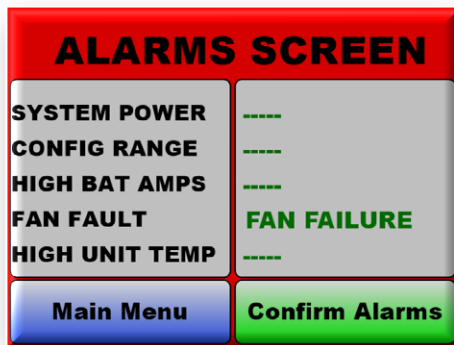

Figure 49- Alarms Screen

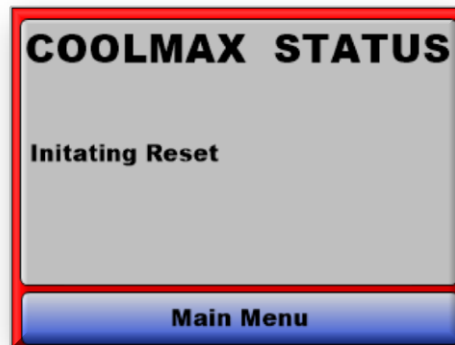

Figure 49A- Notification Screen

Press the Confirm Alarms Button to enable the COOLMAX SR Unit to try and reset the system to clear the alarms. The Notification Screen (Fig.49A) will be shown as it displays the reset status of the COOLMAX SR System. Pressing the Main Menu Button will not reset the alarms and return the user to the Main Menu. If the Alarm still exists after the COOLMAX SR System reboots please contact AERL technical support on advice on how to fix or remove the cause of the alarm.

Important

Even if there are no alarms just pressing the confirm alarms button (Fig.49) will reset the COOLMAX SR

Important

When critical errors occur that causes the output to be shut down the Alarms button on the Real Time Screen (Fig.50) will start to flash. Press the Confirm Alarms button (Fig.50A) to reset the unit and try and rectify the alarms. If the Alarm still exists after the COOLMAX SR System reboots please contact AERL technical support on advice on how to fix or remove the cause of the alarm.

Note: Listen for the Fan Noise while the COOLMAX SR Unit Resets to indicate a successful

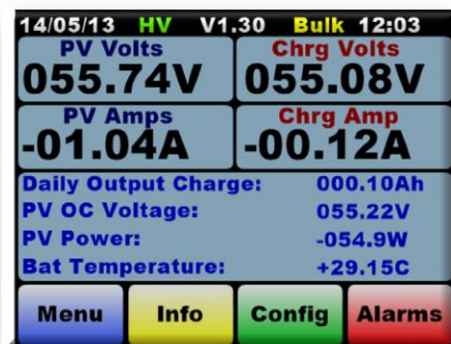

Figure 50 – Real Time Screen

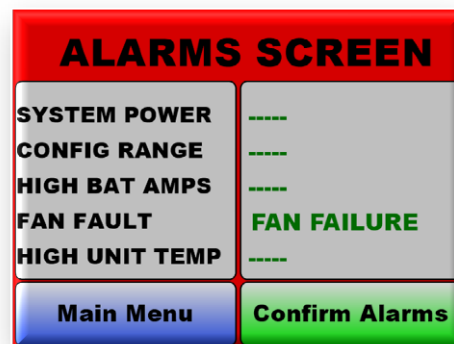

Figure 50A – Alarms Screen

11 LCD POWER SAVING FEATURE

The COOLMAX SR unit is fitted with a power saving feature where the LCD Screen dims after 40 Seconds. This results in the COOLMAX SR unit consuming just 10watts of power once the LCD Screen has been dimmed. To enable the backlight for the LCD Screen to turn back on just touch the LCD Screen. The Dim light function cannot be disabled completely. This power saving feature enables customers to differentiate between a unit that is not powered and a unit which is on but whose screen has been dimmed to save power.

12 OUTPUT CHARGE POWER SWITCH

The COOLMAX SR unit is fitted with a power switch to enable or disable the charge output or when required to be turned off during regular maintenance. The power switch is located at the base of the MPPT unit next to the conduit.



Safety Information

To prevent the possibility of damaging the unit or the battery system it is advisable to turn off the output charge using the power switch during regular maintenance or when adjusting the charge profile.

12.1 BATTERY CHARGE POWER TURN ON

When the unit is first turned on, output battery charge power is disabled. To activate output battery charge power toggle and hold the power switch (located near the conduit entry) in either the up or down position for 5 seconds until the LCD display screen no longer shows it is "OFF" mode (Fig.51)

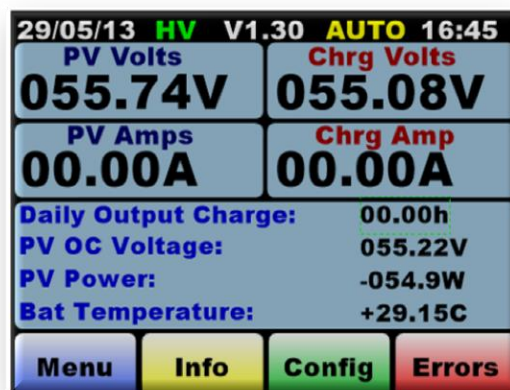

Figure 51 – Battery Charge Power On



Important

If no Battery Output voltage or Input PV Voltage is detected by the COOLMAX SR unit when it attempts to start battery charging, it goes into auto mode whereby it attempts to activate the Output Battery Charge Output every 30 seconds. If Battery Voltage or PV Input is still not detected the unit shutdowns the charge output until the unit tries again on the next 30 second cycle.

12.2 BATTERY CHARGE POWER TURN OFF

Prior to adjusting any charge profile settings or prior to reconnecting output or input breakers that have tripped or if performing any maintenance on the battery system, it is essential to turn off the COOLMAX SR Battery Charge Output. To do this toggle and hold the power switch in either the up or down position for 5 seconds until the LCD display screen shows it is “OFF” mode. (Fig.52)

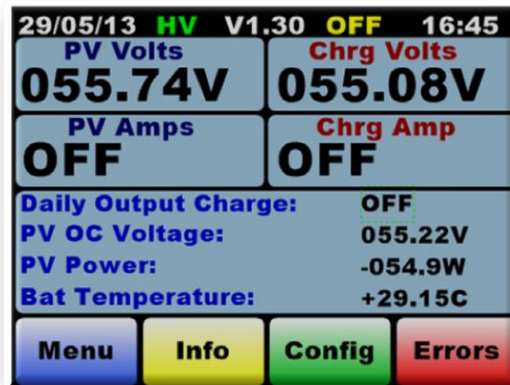

Figure 52 – Battery Charge Power Off

13 PV ARRAY CONFIGURATION NOTES

13.1 OPTIMAL PV ARRAY CONFIGURATION

- The minimum Vmp of the array must be greater than the battery bulk charge point.
- The closer the nominal Vmp of the array is to the nominal battery voltage the more efficient is the COOLMAX SR.
- The input open circuit voltage (Voc) must be above the minimum voltage listed in the datasheet for the COOLMAX SR to run.

13.2 PV INPUT BLOCKING DIODE

A PV Input blocking diode should not be used as long as the open circuit voltage of the PV array is within the range specified by the datasheet for the appropriate COOLMAX SR model and battery voltage.

The idea of the blocking diode is to prevent night time reverse leakage from the battery into the PV array. However the diode introduces power wastage during operation which outweighs the leakage, resulting in a net power loss.

13.3 PV MODULE POWER RATING AND MOUNTING CONSIDERATIONS

The nominal power output rating of a particular PV Module is specified by the PV Module Manufacturer, at One Sun (1000W/sq.m of sunlight radiation) and 25°C.

PV Module Maximum Power Voltage (and consequently maximum power) falls off by 4% per every 10°C that the PV panel rises above this 25°C specification, so typical panel temperatures on a hot

summers day of 65°C will result in a panel power derating of 16% of the manufacturers rating.

It is best to mount the PV Array in a way that the hot air behind the panels can easily escape via the natural breezes or convection. So don't mount the PV Array flat against the roof surface, but ensure there is at least 40mm spacing below the panels. Small gaps (20-30mm) left between adjacent panels are also a good idea to let out the hot air from the sides.



Important: Around 80% of the sun-light energy falling on the solar cells is converted directly into heat, not electricity, and heat is the power output enemy

14 TROUBLESHOOTING

14.1 LOW BATTERY ALARM TRIGGERS OFTEN

This could indicate that the PV system is underpowered, never reaching a full 108% equalise value. The battery life will be severely compromised in this situation. The more often the alarm activates the more power should be added to the PV array.

Solution: Add more PV modules to the array to increase the power output.

If the array is sufficiently powerful, but the alarm is activated frequently check that the unit is set up for the correct voltage of the battery pack. See adjusting the battery float voltage. Also check that the COOLMAX SR is charging the battery by checking the Real Time Screen (Fig.12). If the COOLMAX SR unit is not functioning correctly, contact AERL Technical Support.

14.2 BATTERY BANK USING EXCESSIVE WATER (ELECTROLYTE)

The battery bank is lightly loaded compared to the input PV power and rarely comes off float voltage.

See Section 10 to adjust the Charge Profile.

15 APPENDIX A – CAN COMMUNICATIONS PROTOCOL

15.1 OVERVIEW

15.1.1 Hardware

The CAN hardware interface used is compatible with the CAN 2.0B standard. The supported bit rates (bits per second) are 1 Mbps, 500 kbps (default), 250 kbps, 125 kbps, 100 kbps and 50 kbps.

15.1.2 Software

The CAN protocol uses data frames for most communication. Remote frames are also enabled. All measurement data is transmitted using IEEE single-precision 32-bit format (IEEE 754) with most significant byte (MSB) sent first.

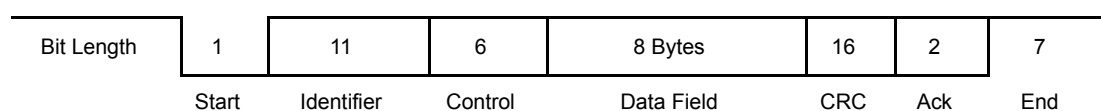

Figure 53 - CAN Data Frame

15.1.3 Identifier

The identifier field has been split into two sections for the COOLMAX SR. Bits 10-5 contain the device identifier and bits 4-0 contains the message identifier associated with that device, as shown below.

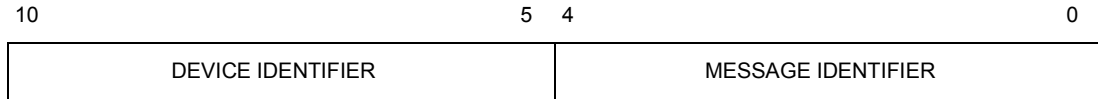

Figure 54 - CAN Device Identifier Address Format

15.1.4 Data Field

The data field in all frames is fixed at 8 bytes (64 bits) which allows space for two IEEE 754 32-bit floating point variables as shown in the Figure below. The data field is sent and expected to be received least significant byte first. This allows a direct overlay of a float[2] array and char[8] array on a little endian processor.

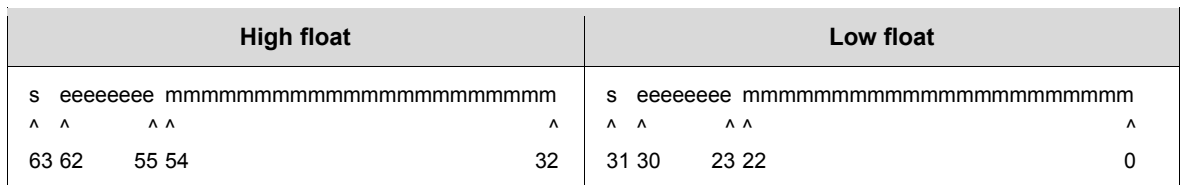

Figure 55 - Format of a Data Field in a Data Frame

15.2 COOLMAX SR BROADCAST MESSAGES

Data frames containing telemetry values are periodically broadcast onto the bus by the COOLMAX SR.

15.2.1 Identification Information

ID: COOLMAX SR Base Address + 0

Variable	Bits	Type	Description
Serial Number	63...32	Uint32	Device serial number, allocated at manufacture.
Product ID	31...0	Uint32	"A001" stored as a string.

15.2.2 PV Voltage/Current Measurement

ID: COOLMAX SR Base Address + 1

Variable	Bits	Type	Description
PV Current	63...32	float	PV Current
PV Voltage	31...0	float	PV Voltage

15.2.3 Output Voltage/Current Measurement

ID: COOLMAX SR Base Address + 2

Variable	Bits	Type	Description
Output Current	63...32	float	Output Current
Output Voltage	31...0	float	Output Voltage

15.2.4 PV Open Circuit Voltage/Output Charge Measurement

ID: COOLMAX SR Base Address + 3

Variable	Bits	Type	Description
Output charge	63...32	float	Output charge
PV OC Voltage	31...0	float	PV OC Voltage

15.2.5 PV Power/Battery Temperature Measurement

ID: COOLMAX SR Base Address + 4

Variable	Bits	Type	Description
Battery Temperature	63...32	float	Battery Temperature
PV Power	31...0	float	PV Power

15.2.6 Active Flags

ID: COOLMAX SR Base Address + 5

Variable	Bits	Type	Description
Unused	63...13	-	-
Panel missing	12	Boolean	Input voltage indicates panel missing
Log file full	11	Boolean	Log file full
Maximizer fault	10	Boolean	Regulation or power stage fault
Bat temp sensor fault	9	Boolean	Battery temperature sensor fault
Not used	8	Boolean	-
Not used	7	Boolean	-
Hi bat temp	6	Boolean	High battery temp fault
Bat current	5	Boolean	High battery discharge current fault
Iout fault	4	Boolean	High output current fault
Vout high fault	3	Boolean	High output voltage fault
Not used	2	-	-

Variable	Bits	Type	Description
Vout low fault	1	Boolean	Low output voltage fault
Vout low warning	0	Boolean	Low output voltage warning

15.2.7 Time

ID: COOLMAX SR Base Address + 7

Variable	Bits	Type	Description
Time	63...0	Uint64	System Unix time

15.3 COOLMAX SR COMMAND MESSAGES

15.3.1 Reset Command

ID: Driver Controls Base Address + 23

Variable	Bits	Units	Description
Unused	63...32	Unit32	-
Reset command string ALL – full reset RCO – remote config reset	31...0	Uint32	Send 'ALL' or 'RCO' as a string ("00000ALL") COOLMAX SR replies with Y or N in byte 0

16 APPENDIX B – MODBUS COMMUNICATIONS PROTOCOL

16.1 OVERVIEW

16.1.1 Hardware

The Modbus hardware interface used is compatible with the Modbus RTU standard. The supported bit rates (bits per second) is 9600 bps.

Software

All measurement data is transmitted using IEEE single-precision 32-bit format (IEEE 754) with most significant byte (MSB) sent first.

16.1.2 Modbus Address

The Modbus address is a single byte field, valid address ranges from 1 to 128.

16.2 MODBUS MEMORY MAP (DISCRETE INPUTS)

Single-Bit (Read-Only)

Returns : 0 to 255 (**byte** data type) 0x00 to 0xFF (i.e. 8 Bits)

Notes : When a request is sent to read a discrete input, a byte is returned containing the values of 8 consecutive inputs, with the addressed input as the LSB. If the returned input quantity is not a multiple of 8 bits, then the final data byte is padded with zeros.



Memory Offset	Input Address	Description	Input Range	Data Range	Read/Write	Comment
-	10000	-	-	-	-	-
0	10001	ACTIVE EVENTS System Power	Bit	0 or 1	Read-Write	0 → Event Cleared 1 → Event Triggered
1	10002	ACTIVE EVENTS Low Out Voltage Warning	Bit	0 or 1	Read-Write	0 → Event Cleared 1 → Event Triggered
2	10003	ACTIVE EVENTS Low Out Voltage Fault	Bit	0 or 1	Read-Write	0 → Event Cleared 1 → Event Triggered
3	10004	ACTIVE EVENTS Low Out Voltage Gen-Set	Bit	0 or 1	Read-Write	0 → Event Cleared 1 → Event Triggered
4	10005	ACTIVE EVENTS High Out Voltage Fault	Bit	0 or 1	Read-Write	0 → Event Cleared 1 → Event Triggered
5	10006	ACTIVE EVENTS High Out Current Fault	Bit	0 or 1	Read-Write	0 → Event Cleared 1 → Event Triggered
6	10007	ACTIVE EVENTS High Discharge Current Fault	Bit	0 or 1	Read-Write	0 → Event Cleared 1 → Event Triggered
7	10008	ACTIVE EVENTS High Battery Temperature Fault	Bit	0 or 1	Read-Write	0 → Event Cleared 1 → Event Triggered
8	10009	ACTIVE EVENTS Input Breaker Open	Bit	0 or 1	Read-Write	0 → Event Cleared 1 → Event Triggered
9	10010	ACTIVE EVENTS Output Breaker Open	Bit	0 or 1	Read-Write	0 → Event Cleared 1 → Event Triggered
10	10011	ACTIVE EVENTS Temperature Sensor Fault	Bit	0 or 1	Read-Write	0 → Event Cleared 1 → Event Triggered
11	10012	ACTIVE EVENTS Negative PV Current Shutdown	Bit	0 or 1	Read-Write	0 → Event Cleared 1 → Event Triggered

Memory Offset	Input Address	Description	Input Range	Data Range	Read/Write	Comment
12	10013	ACTIVE EVENTS High PV Current Shutdown	Bit	0 or 1	Read-Write	0 → Event Cleared 1 → Event Triggered
13	10014	ACTIVE EVENTS High PV Voltage Shutdown	Bit	0 or 1	Read-Write	0 → Event Cleared 1 → Event Triggered
14	10015	ACTIVE EVENTS High Output Current Shutdown	Bit	0 or 1	Read-Write	0 → Event Cleared 1 → Event Triggered
15	10016	ACTIVE EVENTS High Output Voltage Shutdown	Bit	0 or 1	Read-Write	0 → Event Cleared 1 → Event Triggered
16	10017	ACTIVE EVENTS Heat-Sink Temperature Too High	Bit	0 or 1	Read-Write	0 → Event Cleared 1 → Event Triggered
17	10018	ACTIVE EVENTS Fan Fault	Bit	0 or 1	Read-Write	0 → Event Cleared 1 → Event Triggered
18	10019	ACTIVE EVENTS Log File Full	Bit	0 or 1	Read-Write	0 → Event Cleared 1 → Event Triggered
19	10020	ACTIVE EVENTS Solar Panel Missing	Bit	0 or 1	Read-Write	0 → Event Cleared 1 → Event Triggered
20	10021	ACTIVE EVENTS Config Value Out-Of-Range	Bit	0 or 1	Read-Write	0 → Event Cleared 1 → Event Triggered
21	10022	ACTIVE EVENTS (Not Used)	Bit	0 or 1	Read-Write	Reserved
22	10023	ACTIVE EVENTS (Not Used)	Bit	0 or 1	Read-Write	Reserved
23	10024	ACTIVE EVENTS (Not Used)	Bit	0 or 1	Read-Write	Reserved
24	10025	ACTIVE EVENTS (Not Used)	Bit	0 or 1	Read-Write	Reserved
25	10026	ACTIVE EVENTS (Not Used)	Bit	0 or 1	Read-Write	Reserved
26	10027	ACTIVE EVENTS (Not Used)	Bit	0 or 1	Read-Write	Reserved
27	10028	ACTIVE EVENTS (Not Used)	Bit	0 or 1	Read-Write	Reserved

Memory Offset	Input Address	Description	Input Range	Data Range	Read/Write	Comment
28	10029	ACTIVE EVENTS (Not Used)	Bit	0 or 1	Read-Write	Reserved
29	10030	ACTIVE EVENTS (Not Used)	Bit	0 or 1	Read-Write	Reserved
30	10031	ACTIVE EVENTS (Not Used)	Bit	0 or 1	Read-Write	Reserved
31	10032	ACTIVE EVENTS (Not Used)	Bit	0 or 1	Read-Write	Reserved
32	10033	STATUS – Configuration Factory Config CRC	Bit	0 or 1	Read-Only	0 → CRC Invalid 1 → CRC Valid
33	10034	STATUS – Configuration Factory Config Check	Bit	0 or 1	Read-Only	0 → Check Failed 1 → Check Passed
34	10035	STATUS – Configuration User Config CRC	Bit	0 or 1	Read-Only	0 → CRC Invalid 1 → CRC Valid
35	10036	STATUS – Configuration User Config Check	Bit	0 or 1	Read-Only	0 → Check Failed 1 → Check Passed
36	10037	STATUS – Configuration Event Config CRC	Bit	0 or 1	Read-Only	0 → CRC Invalid 1 → CRC Valid
37	10038	STATUS – Configuration Event Config Check	Bit	0 or 1	Read-Only	0 → Check Failed 1 → Check Passed
38	10039	STATUS – Configuration Telemetry Config CRC	Bit	0 or 1	Read-Only	0 → CRC Invalid 1 → CRC Valid
39	10040	STATUS – Configuration Telemetry Config Check	Bit	0 or 1	Read-Only	0 → Check Failed 1 → Check Passed
40	10041	STATUS – Statistics (Not Used)	Bit	0 or 1	Read-Only	Reserved
41	10042	STATUS – Statistics (Not Used)	Bit	0 or 1	Read-Only	Reserved
42	10043	STATUS – Statistics (Not Used)	Bit	0 or 1	Read-Only	Reserved
43	10044	STATUS – Statistics (Not Used)	Bit	0 or 1	Read-Only	Reserved
44	10045	STATUS – Statistics (Not Used)	Bit	0 or 1	Read-Only	Reserved

Memory Offset	Input Address	Description	Input Range	Data Range	Read/Write	Comment
45	10046	STATUS – Statistics (Not Used)	Bit	0 or 1	Read-Only	Reserved
46	10047	STATUS – Statistics (Not Used)	Bit	0 or 1	Read-Only	Reserved
47	10048	STATUS – Statistics (Not Used)	Bit	0 or 1	Read-Only	Reserved
48	10049	STATUS – Flags (Not Used)	Bit	0 or 1	Read-Only	Reserved
49	10050	STATUS – Flags (Not Used)	Bit	0 or 1	Read-Only	Reserved
50	10051	STATUS – Flags (Not Used)	Bit	0 or 1	Read-Only	Reserved
51	10052	STATUS – Flags (Not Used)	Bit	0 or 1	Read-Only	Reserved
52	10053	STATUS – Flags (Not Used)	Bit	0 or 1	Read-Only	Reserved
53	10054	STATUS – Flags (Not Used)	Bit	0 or 1	Read-Only	Reserved
54	10055	STATUS – Flags (Not Used)	Bit	0 or 1	Read-Only	Reserved
55	10056	STATUS – Flags (Not Used)	Bit	0 or 1	Read-Only	Reserved
56	10057	STATUS – Telemetry (Not Used)	Bit	0 or 1	Read-Only	Reserved
57	10058	STATUS – Telemetry (Not Used)	Bit	0 or 1	Read-Only	Reserved
58	10059	STATUS – Telemetry (Not Used)	Bit	0 or 1	Read-Only	Reserved
59	10060	STATUS – Telemetry (Not Used)	Bit	0 or 1	Read-Only	Reserved
60	10061	STATUS – Telemetry (Not Used)	Bit	0 or 1	Read-Only	Reserved
61	10062	STATUS – Telemetry (Not Used)	Bit	0 or 1	Read-Only	Reserved
62	10063	STATUS – Telemetry (Not Used)	Bit	0 or 1	Read-Only	Reserved
63	10064	STATUS – Telemetry (Not Used)	Bit	0 or 1	Read-Only	Reserved
64	10065	STATUS – Communications (Not Used)	Bit	0 or 1	Read-Only	Reserved
65	10066	STATUS – Communications (Not Used)	Bit	0 or 1	Read-Only	Reserved
66	10067	STATUS – Communications (Not Used)	Bit	0 or 1	Read-Only	Reserved
67	10068	STATUS – Communications (Not Used)	Bit	0 or 1	Read-Only	Reserved

Memory Offset	Input Address	Description	Input Range	Data Range	Read/Write	Comment
68	10069	STATUS – Communications (Not Used)	Bit	0 or 1	Read-Only	Reserved
69	10070	STATUS – Communications (Not Used)	Bit	0 or 1	Read-Only	Reserved
70	10071	STATUS – Communications (Not Used)	Bit	0 or 1	Read-Only	Reserved
71	10072	STATUS – Communications (Not Used)	Bit	0 or 1	Read-Only	Reserved
72	10073	STATUS – Flash (Not Used)	Bit	0 or 1	Read-Only	Reserved
73	10074	STATUS – Flash (Not Used)	Bit	0 or 1	Read-Only	Reserved
74	10075	STATUS – Flash (Not Used)	Bit	0 or 1	Read-Only	Reserved
75	10076	STATUS – Flash (Not Used)	Bit	0 or 1	Read-Only	Reserved
76	10077	STATUS – Flash (Not Used)	Bit	0 or 1	Read-Only	Reserved
77	10078	STATUS – Flash (Not Used)	Bit	0 or 1	Read-Only	Reserved
78	10079	STATUS – Flash (Not Used)	Bit	0 or 1	Read-Only	Reserved
79	10080	STATUS – Flash (Not Used)	Bit	0 or 1	Read-Only	Reserved
80	10081	STATUS – Control Master / Slave	Bit	0 or 1	Read-Only	0 → Device is Master 1 → Device is Slave
81	10082	STATUS – Control Active Set-Point Mode	Bit	0 or 1	Read-Only	0 → Using Float Set-Point 1 → Using Bulk Set-Point
82	10083	STATUS – Control Control Mode	Bit	0 or 1	Read-Only	0 → MPPT 1 → Output Voltage 2 → Input Voltage 3 → Not Used
83	10084					
84	10085	STATUS – Control (Not Used)	Bit	0 or 1	Read-Only	Reserved

Memory Offset	Input Address	Description	Input Range	Data Range	Read/Write	Comment
85	10086	STATUS – Control (Not Used)	Bit	0 or 1	Read-Only	Reserved
86	10087	STATUS – Control (Not Used)	Bit	0 or 1	Read-Only	Reserved
87	10088	STATUS – Control (Not Used)	Bit	0 or 1	Read-Only	Reserved
88	10089	STATUS – Safety Shutdown State	Bit	0 or 1	Read-Only	0 → Shutdown 1 → Operating
89	10090	STATUS – Safety (Not Used)	Bit	0 or 1	Read-Only	Reserved
90	10091	STATUS – Safety (Not Used)	Bit	0 or 1	Read-Only	Reserved
92	10093	STATUS – Safety (Not Used)	Bit	0 or 1	Read-Only	Reserved
93	10094	STATUS – Safety (Not Used)	Bit	0 or 1	Read-Only	Reserved
94	10095	STATUS – Safety (Not Used)	Bit	0 or 1	Read-Only	Reserved
95	10096	STATUS – Safety (Not Used)	Bit	0 or 1	Read-Only	Reserved

MODBUS MEMORY MAP (Input Registers)

16-Bit (Register)

Returns : 0 to 65535 (**unsigned short** data type) 0x0000 to 0xFFFF (i.e. 2 x 8 Bits)

Notes : When a request is sent to read an input register, two bytes are returned for each register.
 The result may be stored as an unsigned short data type.
 Integers and Floating point values (32-bits) are stored over two registers.
 Long values (64-bits) are stored over 4 registers.



USER MANUAL

COOLMAX SR

Australian Energy Research Laboratories
AER07.004 – Version 10
31st May 2013

Memory Offset	Register Address	Description	Register Range	Data Range	Read/Write	Comment
-	30000	-	-	-	-	-
0	30001	LIVE TELEMETRY Product ID (8 Characters)	16-Bits	0 to 65535	Read-Only	Product ID (Byte 1 – High) Product ID (Byte 2 – Low)
1	30002		16-Bits	0 to 65535	Read-Only	Product ID (Byte 3 – High) Product ID (Byte 4 – Low)
2	30003		16-Bits	0 to 65535	Read-Only	Product ID (Byte 5 – High) Product ID (Byte 6 – Low)
3	30004		16-Bits	0 to 65535	Read-Only	Product ID (Byte 7 – High) Product ID (Byte 8 – Low)
4	30005	LIVE TELEMETRY Serial Number (8 Characters)	16-Bits	0 to 65535	Read-Only	Serial # (Byte 1 – High) Serial # (Byte 2 – Low)
5	30006		16-Bits	0 to 65535	Read-Only	Serial # (Byte 3 – High) Serial # (Byte 4 – Low)
6	30007		16-Bits	0 to 65535	Read-Only	Serial # (Byte 5 – High) Serial # (Byte 6 – Low)
7	30008		16-Bits	0 to 65535	Read-Only	Serial # (Byte 7 – High) Serial # (Byte 8 – Low)
8	30009	LIVE TELEMETRY PV Voltage (Volts) (Float)	16-Bits	0 to 65535	Read-Only	PV Voltage (Byte 1 – High) PV Voltage (Byte 2 – Low)
9	30010		16-Bits	0 to 65535	Read-Only	PV Voltage (Byte 3 – High) PV Voltage (Byte 4 – Low)
10	30011	LIVE TELEMETRY PV Current (Amps) (Float)	16-Bits	0 to 65535	Read-Only	PV Current (Byte 1 – High) PV Current (Byte 2 – Low)
11	30012		16-Bits	0 to 65535	Read-Only	PV Current (Byte 3 – High) PV Current (Byte 4 – Low)
12	30013	LIVE TELEMETRY Output Voltage (Volts) (Float)	16-Bits	0 to 65535	Read-Only	Out Voltage (Byte 1 – High) Out Voltage (Byte 2 – Low)
13	30014		16-Bits	0 to 65535	Read-Only	Out Voltage (Byte 3 – High) Out Voltage (Byte 4 – Low)
14	30015	LIVE TELEMETRY Output Current (Amps) (Float)	16-Bits	0 to 65535	Read-Only	Out Current (Byte 1 – High) Out Current (Byte 2 – Low)
15	30016		16-Bits	0 to 65535	Read-Only	Out Current (Byte 3 – High) Out Current (Byte 4 – Low)
16	30017	LIVE TELEMETRY PV Open-Circuit Voltage (Volts) (Float)	16-Bits	0 to 65535	Read-Only	OC Voltage (Byte 1 – High) OC Voltage (Byte 2 – Low)
17	30018		16-Bits	0 to 65535	Read-Only	OC Voltage (Byte 3 – High) OC Voltage (Byte 4 – Low)
18	30019	LIVE TELEMETRY Daily Output Charge (Ah) (Float)	16-Bits	0 to 65535	Read-Only	Out Charge (Byte 1 – High) Out Charge (Byte 2 – Low)
19	30020		16-Bits	0 to 65535	Read-Only	Out Charge (Byte 3 – High) Out Charge (Byte 4 – Low)
20	30021	LIVE TELEMETRY Photovoltaic Power (W) (Float)	16-Bits	0 to 65535	Read-Only	PV Power (Byte 1 – High) PV Power (Byte 2 – Low)
21	30022		16-Bits	0 to 65535	Read-Only	PV Power (Byte 3 – High) PV Power (Byte 4 – Low)

Memory Offset	Register Address	Description	Register Range	Data Range	Read/Write	Comment
22	30023	LIVE TELEMETRY Case Temperature (°C) (Float)	16-Bits	0 to 65535	Read-Only	Out Current (Byte 1 – High) Out Current (Byte 2 – Low)
23	30024		16-Bits	0 to 65535	Read-Only	Out Current (Byte 3 – High) Out Current (Byte 4 – Low)
24	30025	LIVE TELEMETRY Active Events (UInt32)	16-Bits	0 to 65535	Read-Only	Active Events (Byte 1 – High) Active Events (Byte 2 – Low)
25	30026		16-Bits	0 to 65535	Read-Only	Active Events (Byte 3 – High) Active Events (Byte 4 – Low)
26	30027	LIVE TELEMETRY Status Flags (UInt64)	16-Bits	0 to 65535	Read-Only	Status Flags (Byte 1 – High) Status Flags (Byte 2 – Low)
27	30028		16-Bits	0 to 65535	Read-Only	Status Flags (Byte 3 – High) Status Flags (Byte 4 – Low)
28	30029		16-Bits	0 to 65535	Read-Only	Status Flags (Byte 5 – High) Status Flags (Byte 6 – Low)
29	30030		16-Bits	0 to 65535	Read-Only	Status Flags (Byte 7 – High) Status Flags (Byte 8 – Low)
30	30031	LIVE TELEMETRY Unix Time (UInt64)	16-Bits	0 to 65535	Read-Only	Unix Time (Byte 1 – High) Unix Time (Byte 2 – Low)
31	30032		16-Bits	0 to 65535	Read-Only	Unix Time (Byte 3 – High) Unix Time (Byte 4 – Low)
32	30033		16-Bits	0 to 65535	Read-Only	Unix Time (Byte 5 – High) Unix Time (Byte 6 – Low)
33	30034		16-Bits	0 to 65535	Read-Only	Unix Time (Byte 7 – High) Unix Time (Byte 8 – Low)
40	30041	SYSTEM INFO Hardware Version (8 Characters)	16-Bits	0 to 65535	Read-Only	Hardware Ver. (Byte 1 – High) Hardware Ver. (Byte 2 – Low)
41	30042		16-Bits	0 to 65535	Read-Only	Hardware Ver. (Byte 3 – High) Hardware Ver. (Byte 4 – Low)
42	30043		16-Bits	0 to 65535	Read-Only	Hardware Ver. (Byte 5 – High) Hardware Ver. (Byte 6 – Low)
43	30044		16-Bits	0 to 65535	Read-Only	Hardware Ver. (Byte 7 – High) Hardware Ver. (Byte 8 – Low)

Memory Offset	Register Address	Description	Register Range	Data Range	Read/Write	Comment
44	30045	SYSTEM INFO Firmware Version (8 Characters)	16-Bits	0 to 65535	Read-Only	Firmware Ver. (Byte 1 – High) Firmware Ver. (Byte 2 – Low)
45	30046		16-Bits	0 to 65535	Read-Only	Firmware Ver. (Byte 3 – High) Firmware Ver. (Byte 4 – Low)
46	30047		16-Bits	0 to 65535	Read-Only	Firmware Ver. (Byte 5 – High) Firmware Ver. (Byte 6 – Low)
47	30048		16-Bits	0 to 65535	Read-Only	Firmware Ver. (Byte 7 – High) Firmware Ver. (Byte 8 – Low)
48	30049	SYSTEM INFO Model Type (4 Characters)	16-Bits	0 to 65535	Read-Only	Model Type (Byte 1 – High) Model Type (Byte 2 – Low)
49	30050		16-Bits	0 to 65535	Read-Only	Model Type (Byte 3 – High) Model Type (Byte 4 – Low)
50	30051	SYSTEM INFO Product ID (8 Characters)	16-Bits	0 to 65535	Read-Only	Product ID (Byte 1 – High) Product ID (Byte 2 – Low)
51	30052		16-Bits	0 to 65535	Read-Only	Product ID (Byte 3 – High) Product ID (Byte 4 – Low)
52	30053		16-Bits	0 to 65535	Read-Only	Product ID (Byte 5 – High) Product ID (Byte 6 – Low)
53	30054		16-Bits	0 to 65535	Read-Only	Product ID (Byte 7 – High) Product ID (Byte 8 – Low)
54	30055	SYSTEM INFO Serial Number (8 Characters)	16-Bits	0 to 65535	Read-Only	Serial # (Byte 1 – High) Serial # (Byte 2 – Low)
55	30056		16-Bits	0 to 65535	Read-Only	Serial # (Byte 3 – High) Serial # (Byte 4 – Low)
56	30057		16-Bits	0 to 65535	Read-Only	Serial # (Byte 5 – High) Serial # (Byte 6 – Low)
57	30058		16-Bits	0 to 65535	Read-Only	Serial # (Byte 7 – High) Serial # (Byte 8 – Low)
58	30059	SYSTEM INFO Reserved	16-Bits	0 to 65535	Read-Only	Reserved
59	30060	SYSTEM INFO Reserved	16-Bits	0 to 65535	Read-Only	Reserved
60	30061	SYSTEM INFO Reserved	16-Bits	0 to 65535	Read-Only	Reserved
61	30062	SYSTEM INFO Reserved	16-Bits	0 to 65535	Read-Only	Reserved
62	30063	SYSTEM INFO Reserved	16-Bits	0 to 65535	Read-Only	Reserved
63	30064	SYSTEM INFO Reserved	16-Bits	0 to 65535	Read-Only	Reserved